

Xolair®

Systemic drug for obstructive airway diseases

DESCRIPTION AND COMPOSITION**Pharmaceutical form(s)****Powder and solvent for solution for injection**

Powder: white to off-white lyophilizate in a glass vial.

Solvent: clear and colorless solution in a glass ampoule

One vial of Xolair® 75 mg powder and solvent for solution for injection delivers 75 mg of omalizumab. Reconstituted Xolair contains 125 mg/mL of omalizumab (75 mg in 0.6 mL).

One vial of Xolair® 150 mg powder and solvent for solution for injection delivers 150 mg of omalizumab. Reconstituted Xolair contains 125 mg/mL of omalizumab (150 mg in 1.2 mL).

Solution for injection in pre-filled syringe

Clear to slightly opalescent, colorless to pale brownish-yellow solution in a pre-filled syringe.

Each pre-filled syringe of 0.5 mL contains 75 mg of omalizumab.

Each pre-filled syringe of 1 mL contains 150 mg of omalizumab.

Active substance

Omalizumab is a humanized monoclonal antibody manufactured from a mammalian cell line.

Certain dosage strengths and dosage forms may not be available in all countries.

Excipients**Powder and solvent for solution for injection**

Powder: Sucrose, L-histidine, L-histidine hydrochloride monohydrate, polysorbate 20

Solvent: Water for injection

Solution for injection in pre-filled syringe

L-arginine hydrochloride, L-histidine hydrochloride monohydrate, L-histidine, polysorbate 20, water for injection.

Pharmaceutical formulations may vary between countries.

INDICATIONS**Allergic Asthma**

Xolair (omalizumab) is indicated for adults and children (6 years of age and above) with moderate to severe persistent allergic asthma whose symptoms are inadequately controlled with inhaled corticosteroids (ICS).

Xolair has been shown to decrease the incidence of asthma exacerbations in these patients. Safety and efficacy have not been established in other allergic conditions.

Nasal Polyps

Xolair (omalizumab) is indicated for adults (18 years of age and above) for the treatment of nasal polyps with inadequate response to intranasal corticosteroids.

Chronic Spontaneous Urticaria (CSU)

Xolair (omalizumab) is indicated for adults and adolescents (12 years of age and above) with chronic spontaneous urticaria refractory to standard of care.

DOSAGE REGIMEN AND ADMINISTRATION

Dosage regimen for Allergic Asthma and Nasal Polyps

Dosing for asthma and nasal polyps follows the same dosing principles. The appropriate dose and dosing frequency of Xolair for these conditions is determined by baseline immunoglobulin E (IgE) (IU/mL), measured before the start of treatment, and body weight (kg). Prior to initial dosing, patients should have their IgE level determined by any commercial serum total IgE assay for their dose assignment. Based on these measurements 75 to 600 mg of Xolair in 1 to 4 injections may be needed for each administration. See Tables 1 and 2 for a conversion chart and Tables 3 and 4 for dose determination. For doses of 225, 375 or 525 mg Xolair, 150 mg can be used in combination with Xolair 75 mg.

Patients whose baseline IgE levels or body weight in kilograms are outside the limits of the dosing table should not be given Xolair.

Table 1 Conversion from dose to number of vials, number of injections and total injection volume for each administration

Dose (mg)	Number of vials		Number of injections	Total injection volume (mL)
	75 mg ^a	150 mg ^b		
75	1 ^c	0	1	0.6
150	0	1	1	1.2
225	1 ^c	1	2	1.8
300	0	2	2	2.4
375	1 ^c	2	3	3.0
450	0	3	3	3.6
525	1 ^c	3	4	4.2
600	0	4	4	4.8

^a 0.6 mL = maximum delivered volume per vial (Xolair 75 mg).

^b 1.2 mL = maximum delivered volume per vial (Xolair 150 mg).

^c or use 0.6 mL from a 150 mg vial.

Table 2 Conversion from dose to number of pre-filled syringes, number of injections and total injection volume for each administration

Dose (mg)	Number of syringes		Number of injections	Total injection volume (mL)
	75 mg	150 mg		
75	1	0	1	0.5
150	0	1	1	1.0
225	1	1	2	1.5
300	0	2	2	2.0
375	1	2	3	2.5
450	0	3	3	3.0
525	1	3	4	3.5
600	0	4	4	4.0

Treatment duration, monitoring and dose adjustments

In clinical trials for allergic asthma there were reductions in asthma exacerbation events and rescue medication use with improvements in symptom scores during the first 16 weeks of treatment. At least 12 weeks of treatment is required to adequately assess whether or not a patient is responding to Xolair.

In clinical trials for nasal polyps, changes in nasal polyps score (NPS) and nasal congestion score (NCS) were observed as early as the first assessment at 4 weeks. The need for continued therapy should be periodically reassessed based upon the patient's disease severity and level of symptom control.

Xolair is intended for long-term treatment. Discontinuation generally results in a return to elevated free IgE levels and associated symptoms.

Total IgE levels are elevated during treatment and remain elevated for up to one year after the discontinuation of treatment. Therefore, re-testing of IgE levels during Xolair treatment cannot be used as a guide for dose determination. Dose determination after treatment interruptions lasting less than one year should be based on serum IgE levels obtained at the initial dose determination. Total serum IgE levels may be re-tested for dose determination if treatment with Xolair has been interrupted for one year or more.

Doses should be adjusted for significant changes in body weight (see **Tables 3 and 4**).

Table 3 ADMINISTRATION EVERY 4 WEEKS - Allergic Asthma and Nasal Polyps. Xolair doses (milligrams per dose) administered by subcutaneous injection every 4 weeks

Baseline IgE (IU/ml)	Body weight (kg)									
	≥20-25*	>25-30*	>30-40	>40-50	>50-60	>60-70	>70-80	>80-90	>90-125	>125-150
≥30–100	75	75	75	150	150	150	150	150	300	300
>100–200	150	150	150	300	300	300	300	300	450	600
>200–300	150	150	225	300	300	450	450	450	600	

>300–400	225	225	300	450	450	450	600	600	
>400–500	225	300	450	450	600	600			
>500–600	300	300	450	600	600				
>600–700	300		450	600	ADMINISTRATION EVERY 2 WEEKS SEE TABLE 4				

*Body weights below 30 kg were not studied in the pivotal trials for nasal polyps

Table 4 ADMINISTRATION EVERY 2 WEEKS – Allergic Asthma and Nasal Polyps. Xolair doses (milligrams per dose) administered by subcutaneous injection every 2 weeks

Baseline IgE (IU/ml)	Body weight (kg)															
	≥20- 25 *	>25-30 *	>30-40	>40- 50	>50- 60	>60- 70	>70- 80	>80- 90	>90-125	>125-150	>150- 200*					
≥ 30-100	ADMINISTRATION EVERY 4 WEEKS SEE ABOVE										225					
> 100-200											375					
> 200-300											375	525				
> 300-400											450	525				
> 400-500											375	375	525	600		
> 500-600											375	450	450	600		
> 600-700		225											375	450	450	525
> 700-800	225	225	300	375	450	450	525	600								
> 800-900	225	225	300	375	450	525	600									
> 900-1000	225	300	375	450	525	600										
> 1000-1100	225	300	375	450	600	Insufficient Data to Recommend a Dose										
> 1100-1200	300	300	450	525	600											
> 1200-1300	300	375	450	525												
> 1300-1500	300	375	525	600												

*Body weights below 30 kg and above 150 kg were not studied in the pivotal trials for nasal polyps

Dosage regimen for Chronic Spontaneous Urticaria (CSU)

The recommended dose is 300 mg by subcutaneous injection every four weeks. Some patients may achieve control of their symptoms with a dose of 150 mg every four weeks.

Prescribers are advised to periodically reassess the need for continued therapy.

Special populations

Renal or hepatic impairment

There have been no studies on the effect of impaired renal or hepatic function on the pharmacokinetics of omalizumab. Because omalizumab clearance at clinical doses is dominated by IgG clearance process, including degradation in the reticular endothelial system (RES) it is unlikely to be altered by renal or hepatic impairment. While no particular dose adjustment is recommended, Xolair should be administered with caution in these patients (see section WARNINGS AND PRECAUTIONS).

Pediatric patients

In allergic asthma, safety and efficacy in patients below the age of 6 years have not been established and use of Xolair in such patients is therefore not recommended.

In nasal polyps, safety and efficacy in patients below the age of 18 years have not been established.

In chronic spontaneous urticaria, safety and efficacy in patients below the age of 12 years have not been established.

Geriatric patients (65 years or above)

There are limited data available on the use of Xolair in patients 65 years and older but there is no evidence that elderly patients require a different dosage from younger adult patients.

Method of administration

Powder and solvent for solution for injection

For subcutaneous administration only. Xolair must not be administered by the intravenous or intramuscular route.

Doses of more than 150 mg should be divided across two or more injection sites.

There is limited experience with self-administration of Xolair powder and solvent for solution for injection. Therefore treatment with this formulation is intended to be administered by a healthcare professional only.

Full instructions for use are provided in section INSTRUCTION FOR USE and HANDLING.

Pre-filled syringe

For subcutaneous administration only. Xolair must not be administered by the intravenous or intramuscular route.

Doses of more than 150 mg should be divided across two or more injection sites.

CONTRAINDICATIONS

Hypersensitivity to the active substance or to any of the excipients (see section DESCRIPTION AND COMPOSITION - Excipients).

WARNINGS AND PRECAUTIONS

Allergic reactions

As with any protein, local or systemic allergic reactions, including anaphylaxis, may occur when taking omalizumab. Anaphylactic reactions were rare in clinical trials (see Section ADVERSE DRUG REACTIONS). In post-marketing experience anaphylaxis and anaphylactoid reactions have been reported following the first or subsequent administrations of Xolair. Most of these reactions occurred within 2 hours. The majority of anaphylactic reactions occurred within the first 3 doses of Xolair. Therefore, the first 3 doses should be administered either by or under the supervision of a healthcare professional. A history of anaphylaxis unrelated to omalizumab may be a risk factor for anaphylaxis following Xolair administration. Therefore, for patients with a known history of anaphylaxis, Xolair should be administered by a health care professional, who should have medications for the treatment of anaphylactic reactions available for immediate use following administration of Xolair. Patients should be informed that such reactions are possible and prompt medical attention should be sought if allergic reactions occur.

As with all recombinant DNA derived humanized monoclonal antibodies patients may in rare cases develop antibodies to omalizumab (see section ADVERSE DRUG REACTIONS).

Serum sickness and serum sickness-like reactions, which are delayed allergic type III reactions, have rarely been seen in patients treated with humanized monoclonal antibodies including omalizumab. The onset has typically been 1 to 5 days after administration of the first or subsequent injections, also after long duration of treatment. Symptoms suggestive of serum sickness include arthritis/arthralgia, rash (urticaria or other forms), fever and lymphadenopathy. Antihistamines and corticosteroids may be useful for preventing or treating this disorder, and patients should be advised to report any suspected symptoms.

Parasitic infections

IgE may be involved in the immunological response to some infections. In patients at chronic high risk of helminth infection, a placebo-controlled trial in allergic asthma patients showed a slight increase in infection rate with omalizumab, although the course, severity, and response to treatment of infection were unaltered. The helminth infection rate in the overall clinical program, which was not designed to detect such infections, was less than 1 in 1,000 patients. However, caution may be warranted in patients at high risk of helminth infection, in particular when traveling to areas where helminthic infections are endemic. If patients do not respond to the recommended anti-helminth treatment, discontinuation of Xolair should be considered.

General

Xolair is not indicated for the treatment of acute asthma exacerbations, acute bronchospasm or status asthmaticus.

Xolair has not been studied in patients with hyperimmunoglobulin E syndrome or allergic bronchopulmonary aspergillosis or for the prevention of anaphylactic reactions.

Xolair has not been adequately studied in atopic dermatitis, allergic rhinitis or food allergy.

Xolair therapy has not been studied in patients with autoimmune diseases, immune complex-mediated conditions, or those with pre-existing renal or hepatic impairment. Caution should be exercised when administering Xolair in these patient populations.

Abrupt discontinuation of systemic or inhaled corticosteroids after initiation of Xolair therapy in allergic asthma or nasal polyps is not recommended. Decreases in corticosteroids should be performed under the direct supervision of a physician and may need to be performed gradually.

Pre-filled syringe, latex-sensitive individuals

The removable needle cap of Xolair solution for injection in pre-filled syringe contains a derivative of natural rubber latex. Although no natural rubber latex is detected in the removable needle cap, the safe use of Xolair solution for injection in pre-filled syringe in latex-sensitive individuals has not been studied.

ADVERSE DRUG REACTIONS

Allergic Asthma

Summary of the safety profile

During clinical studies with adult and adolescent patients 12 years of age and older, the most commonly reported adverse drug reactions were headaches and injection site reactions, including injection site pain, swelling, erythema and pruritus. In clinical studies with patients 6 to <12 years of age, the most commonly reported adverse drug reactions were headache, pyrexia and upper abdominal pain. Most of the events were mild or moderate in severity.

Tabulated summary of adverse drug reactions from the clinical studies

Table 5 lists the adverse drug reactions recorded in clinical studies in the total allergic asthma safety population treated with Xolair by system organ class and by frequency. Frequencies are defined as: very common ($\geq 1/10$), common ($\geq 1/100$ to $< 1/10$), uncommon ($\geq 1/1,000$ to $< 1/100$), rare ($\geq 1/10,000$ to $< 1/1,000$); very rare ($< 1/10,000$).

Table 5 Adverse drug reactions from the clinical studies in Allergic Asthma

Infections and infestations	
Uncommon	Pharyngitis
Rare	Parasitic infections
Immune system disorders	
Rare	Anaphylactic reaction and other allergic conditions, anti-therapeutic antibody development
Nervous system disorders	
Common	Headache**
Uncommon	Dizziness, somnolence, paraesthesia, syncope
Vascular disorders	
Uncommon	Postural hypotension, flushing
Respiratory , thoracic and mediastinal disorders	
Uncommon	Coughing, allergic bronchospasm
Rare	Laryngoedema
Gastrointestinal disorders	
Common	Abdominal pain upper*
Uncommon	Nausea, diarrhoea, dyspeptic signs and symptoms
Skin and subcutaneous tissue disorders	
Uncommon	Urticaria, rash, pruritus, photosensitivity

Rare	Angioedema
General disorders and administration site conditions	
Very common	Pyrexia*
Common	Injection site reactions such as pain, erythema, pruritus, swelling
Uncommon	Weight increase, fatigue, swelling arms, influenza-like illness

*: In 6 to <12 year old children

**: Very common in 6 to <12 year old children

The frequencies of adverse drug reactions in the active treatment group were very similar to those observed in the control group.

Nasal Polyps

Summary of the safety profile

The data described below reflect data from two placebo-controlled studies in patients ≥ 18 years of age. In these studies, patients received either Xolair 150 to 600 mg every 2 or 4 weeks or placebo. All patients received background intranasal mometasone therapy. The safety profile in patients with nasal polyps was consistent with that in allergic asthma and CSU. The most frequently (>3%) reported adverse drug reactions, which were higher in frequency in comparison to placebo are shown in Table 6.

Tabulated summary of adverse drug reactions from the clinical studies

Table 6 lists the adverse drug reactions recorded in clinical studies in the total nasal polyp safety population treated with Xolair by system organ class and by frequency. Frequencies are defined as: very common ($\geq 1/10$); common ($\geq 1/100$ to $< 1/10$); uncommon ($\geq 1/1,000$ to $< 1/100$); rare ($\geq 1/10,000$ to $< 1/1,000$); very rare ($< 1/10,000$).

Table 6 Adverse drug reactions from the clinical studies in Nasal Polyps

Adverse drug reactions (by MedDRA preferred term)	Omalizumab Nasal Polyp Study1 and Study 2 Pooled		Frequency category
	Placebo N=130	Omalizumab N =135	
Nervous system disorders			
Headache	7 (5.4%)	11 (8.1%)	Common
Dizziness	1 (0.8%)	4 (3.0%)	Common
Musculoskeletal and connective tissue disorders			
Arthralgia	2 (1.5%)	4 (3.0%)	Common
Gastrointestinal disorder			
Abdominal pain upper	1 (0.8%)	4 (3.0%)	Common
General disorders and administration site conditions			
Injection site reactions (Injection site reactions, Injection related reaction, injection site pain)	2 (1.5%)	7 (5.2%)	Common

Chronic Spontaneous Urticaria (CSU)

Summary of the safety profile

The safety and tolerability of omalizumab were investigated with the doses of 75 mg, 150 mg and 300 mg every four weeks in 975 CSU patients, 242 of whom received placebo. 733 patients were treated with omalizumab for up to 12 weeks and 490 patients for up to 24 weeks. 175 and 412 patients were treated for up to 12 weeks and 87 and 333 patients were treated for up to 24 weeks at the recommended doses of 150 mg and 300 mg respectively.

During clinical studies with adult and adolescent patients (12 years of age and older) the most commonly reported adverse drug reactions observed were headache and nasopharyngitis.

Tabulated summary of adverse drug reactions from the clinical studies at the recommended doses (150 mg and 300 mg)

Adverse drug reactions (events occurring in $\geq 1\%$ of patients in any treatment group and $\geq 2\%$ more frequently in any omalizumab treatment group than in the placebo group after medical review) reported at the recommended doses (150 mg and 300 mg) in the three pooled Phase III studies are listed by MedDRA system organ class (Table 7). Within each system organ class, the adverse drug reactions are ranked by frequency, with the most frequent reactions listed first. The corresponding frequency category for each adverse reaction is based on the following convention (CIOMS III): very common ($\geq 1/10$); common ($\geq 1/100$ to $< 1/10$); uncommon ($\geq 1/1,000$ to $< 1/100$); rare ($\geq 1/10,000$ to $< 1/1,000$); very rare ($< 1/10,000$).

Table 7 Adverse drug reactions from the pooled CSU safety database (day 1 to week 12) at the recommended doses

Adverse drug reactions (by MedDRA preferred term)	Omalizumab Studies Q4881g, Q4882g and Q4883g Pooled			Frequency category
	Placebo N=242	150 mg N=175	300 mg N=412	
Infections and infestations				
Nasopharyngitis	17 (7.0%)	16 (9.1%)	27 (6.6%)	Common
Sinusitis	5 (2.1%)	2 (1.1%)	20 (4.9%)	Common
Viral upper respiratory tract infection	0	4 (2.3%)	2 (0.5%)	Common
Nervous system disorders				
Headache	7 (2.9%)	21 (12.0%)	25 (6.1%)	Very common
Musculoskeletal and connective tissue disorders				
Arthralgia	1 (0.4%)	5 (2.9%)	12 (2.9%)	Common

Additional events reported anytime during the day 1 to week 24 treatment period (studies Q4881g and Q4883g) that met the criteria of adverse drug reactions:

Infections and infestations: upper respiratory tract infections (placebo 3.1%, 150 mg 3.4%, 300 mg 5.7%), urinary tract infection (placebo 1.8%, 150 mg 4.6%, 300 mg 2.4%).

Nervous system disorders: sinus headache (placebo 0%, 150 mg 2.3%, 300 mg 0.3%).

Musculoskeletal and connective tissue disorders: myalgia (placebo 0%, 150 mg 2.3%, 300 mg 0.9%), pain in extremity (placebo 0%, 150 mg 3.4%, 300 mg 0.9%), musculoskeletal pain (placebo 0%, 150 mg 2.3%, 300 mg 0.9%).

General disorders and administration site conditions: pyrexia (placebo 1.2%, 150 mg 3.4%, 300 mg 0.9%).

Injection site reactions: injection site reactions occurred during the studies in more omalizumab-treated patients than placebo patients (2.7% at 300 mg, 0.6% at 150 mg, 0.8% with placebo). They included: swelling, erythema, pain, bruising, itching, bleeding and urticaria.

In a 48-week study, 81 CSU patients received omalizumab 300 mg every 4 weeks (see section Clinical studies - CSU). The safety profile of long-term use was similar to the safety profile observed in CSU studies up to 24 weeks.

Adverse drug reactions from spontaneous reports (frequency not known)

The following adverse drug reactions have been identified from post-marketing experience with Xolair via spontaneous reporting. Because these reactions are reported voluntarily from a population of uncertain size, it is not possible to reliably estimate their frequency which is therefore categorized as not known. Adverse drug reactions are listed according to system organ classes in MedDRA. Within each system organ class, ADRs are presented in order of decreasing seriousness:

Immune system disorders (see section WARNINGS AND PRECAUTIONS): Anaphylaxis and anaphylactoid reactions have been reported following the first or subsequent administrations; serum sickness.

Skin and subcutaneous tissue disorders: Alopecia.

Blood and lymphatic system disorders: Idiopathic severe thrombocytopenia.

Respiratory, thoracic and mediastinal disorders: Churg Strauss syndrome (i.e., Eosinophilic Granulomatosis with Polyangiitis)

Musculoskeletal and connective tissue disorders: Arthralgia, myalgia, joint swelling.

Description of adverse drug reactions of special interest

Anaphylaxis

In post-marketing reports, the frequency of anaphylaxis in patients exposed to Xolair use was estimated to be 0.2% based on a total number of anaphylactic reactions observed from an estimated exposure of over 500,000 patient years.

Thrombocytopenia

In clinical trials few patients experienced platelet counts below the lower limit of the normal laboratory range. None of these changes were associated with bleeding episodes or a decrease in hemoglobin. No pattern of persistent decrease in platelet counts has been reported in humans (patients greater than 6 years of age), as was observed in non-human primates (see section NON-CLINICAL SAFETY DATA). Thrombocytopenia has been reported in post-marketing experience.

Parasitic infections

In allergic asthma patients at chronic high risk of helminth infection, a placebo-controlled trial showed a slight numerical increase in infection rate with omalizumab that was not statistically significant. The course, severity, and response to treatment of infections were unaltered (see section WARNINGS AND PRECAUTIONS).

Description of select adverse events

The following adverse events have been reported in patients treated with Xolair, however, the causality of the adverse events and Xolair use has not been established.

Malignancies

During initial clinical trials in adults and adolescents 12 years of age and older, there was a numerical imbalance in cancers arising in the active treatment group, compared with the control group. The number of observed cases was uncommon (<1/100) in both the active and the control group. In a subsequent observational study comparing 5,007 Xolair-treated and 2,829 non-Xolair-treated patients followed for up to 5 years, the incidence rates of primary malignancies per 1,000 patient years were 16.01 (295/18,426 patient years) and 19.07 (190/9,963 patient years), respectively, which does not indicate an increased malignancy risk (rate ratio 0.84, 95% confidence interval, 0.62 to 1.13). In a further analysis of randomized, double-blind, placebo-controlled clinical trials including 4,254 patients on Xolair and 3,178 patients on placebo, Xolair treatment was not associated with an increased malignancy risk based on incidence rates per 1,000 patient years of 4.14 (14/3,382 patient years) for Xolair treated patients and 4.45 (11/2,474 patient years) for placebo patients (rate ratio 0.93, 95% confidence interval 0.39 to 2.27). The overall observed incidence rate of malignancy in the Xolair clinical trial program was comparable to that reported in the general population.

There were no cases of malignancy in clinical trials in the 6 to <12 years of age group with omalizumab; there was a single case of malignancy in the control group.

Arterial Thromboembolic Events (ATE)

In controlled clinical trials and during interim analyses of an observational study, a numerical imbalance of ATEs was observed. ATE included stroke, transient ischemic attack, myocardial infarction, unstable angina, and cardiovascular death (including death from unknown cause). In the final analysis of the observational study, the rate of ATE per 1,000 patient years was 7.52 (115/15,286 patient years) for Xolair-treated patients and 5.12 (51/9,963 patient years) for control patients. In a multivariate analysis controlling for available baseline cardiovascular risk factors, the hazard ratio was 1.32 (95% confidence interval 0.91 to 1.91). In a separate analysis of pooled clinical trials including all randomized double-blind, placebo-controlled clinical trials of 8 or more weeks duration, the rate of ATE per 1,000 patient years was 2.69 (5/1,856 patient years) for Xolair-treated patients and 2.38 (4/1,680 patient years) for placebo patients (rate ratio 1.13, 95% confidence interval 0.24 to 5.71).

INTERACTIONS

Cytochrome P450 enzymes, efflux pumps and protein binding mechanisms are not involved in the clearance of omalizumab; thus, there is little potential for drug-drug interactions. No formal drug or vaccine interaction studies have been performed with Xolair.

There is no pharmacological reason to expect that commonly prescribed medications used in the treatment of asthma, nasal polyps or CSU will interact with omalizumab.

Allergic Asthma

In clinical studies Xolair was commonly used in conjunction with inhaled and oral corticosteroids, inhaled short-acting and long-acting beta2-agonists, leukotriene modifiers, theophylline and oral antihistamines. There was no indication that the safety of Xolair was altered with these other commonly used asthma medications. Limited data are available on the use of Xolair in combination with specific immunotherapy (hypo-sensitisation therapy).

Nasal Polyps

In clinical studies Xolair was used in conjunction with intranasal mometasone spray per protocol. Other commonly used concomitant medications included other intranasal corticosteroids, bronchodilators, antihistamines, leukotriene receptor antagonists, adrenergics/sympathomimetics, and local nasal anesthetics. There was no indication that the safety of Xolair was altered with these other commonly used nasal polyps medications.

Chronic Spontaneous Urticaria (CSU)

In clinical studies in CSU Xolair was used in conjunction with antihistamines (anti-H1, anti-H2) and leukotriene receptor antagonists (LTRAs). *In the phase III studies Q4881g and Q4882g all patients received H1 antihistamines in addition to Xolair or placebo. In the phase III study Q4883g, all patients received one or more H1 antihistamine(s), and/or H2 antihistamines and/or LTRAs in addition to Xolair or placebo.* There was no evidence that the safety of omalizumab was altered when used with these medicinal products relative to its known safety profile in allergic asthma. In addition, a population pharmacokinetic analysis showed no relevant effect of H2 antihistamines and LTRAs on omalizumab pharmacokinetics (see section CLINICAL PHARMACOLOGY).

Usage of Xolair in combination with immunosuppressive therapies has not been studied.

PREGNANCY, LACTATION, FEMALES AND MALES OF REPRODUCTIVE POTENTIAL

Pregnancy

Risk Summary

There are no well-controlled clinical studies of Xolair in pregnant women. A prospective pregnancy registry study (EXPECT) in 250 pregnant women with asthma exposed to Xolair showed the prevalence of major congenital anomalies was similar (8.1% vs 8.9%) between EXPECT and disease matched (moderate and severe asthma) patients. This study cannot definitively establish the absence of any risk, however, because of methodological limitations; including a nonrandomized study design and potential differences between the registry population and the comparator group (see Human Data). IgG molecules are known to cross the placental barrier. In animal reproduction studies, no evidence of fetal harm was observed in cynomolgus monkeys with subcutaneous doses of omalizumab up to approximately 8 times the maximum recommended human dose (MRHD) of 8.75 mg/kg/week on mg/kg basis (see Animal Data).

Clinical considerations

Disease-associated maternal and/or embryo/fetal risk:

In women with poorly or moderately controlled asthma, evidence demonstrates that there is an increased risk of preeclampsia in the mother and prematurity, low birth weight, and small for gestational age in the neonate. The level of asthma control should be closely monitored in pregnant women and treatment adjusted as necessary to maintain optimal control.

Data

Human data

A prospective pregnancy registry study (EXPECT) conducted in the US from 2006 to 2018, included 250 pregnant women with asthma treated with Xolair. 246 of the women were exposed to Xolair in the first trimester of pregnancy and 78.4% (196/250) of the women were exposed to Xolair at least once during all 3 trimesters of pregnancy with an overall median exposure duration of 8.7 months. The EXPECT findings for relevant mother and infant subgroups were compared to age-adjusted frequencies in a disease matched external cohort of 1,153 pregnant women with asthma (without exposure to Xolair) identified from healthcare databases of residents in the Canadian province of Quebec, and termed the Quebec External Comparator Cohort (QECC).

Among EXPECT infants used for comparison to QECC (n=223), the prevalence of major congenital anomalies (8.1%) was similar to that for QECC infants (8.9%). Among EXPECT pregnancies used for comparison to QECC (n=230), 99.1% led to live births, similar to 99.3% for QECC pregnancies.

A sub-study in EXPECT examined platelet levels in 51 infants born to Xolair exposed women, all of them were in the normal range.

Animal data

Reproduction studies in cynomolgus monkeys have been conducted with omalizumab. Subcutaneous doses up to 75 mg/kg per week (at least 8-fold the MRHD of 8.75 mg/kg/week over a 4-week period) of omalizumab did not elicit maternal toxicity, embryotoxicity or teratogenicity when administered throughout organogenesis and did not elicit adverse effects on fetal or neonatal growth when administered throughout late gestation, delivery and nursing.

Doses of omalizumab in excess of the clinical dose have been associated with age-dependent decreases in blood platelets in nonhuman primates, with a greater relative sensitivity in juvenile animals. In a reproduction study in cynomolgus monkeys, there was no clinical evidence of thrombocytopenia (e.g., purpura) in neonatal monkeys from mothers treated with up to 75 mg/kg/week of omalizumab; however, platelet counts were not measured in these offspring.

Lactation

Risk Summary

While omalizumab presence in human milk after administration of Xolair has not been studied, IgGs are present in human milk and therefore it is expected that omalizumab will be present in human milk. The frequency of infant infections identified in EXPECT was evaluated as an indirect measure of immune system development after exposure during pregnancy or through breast-feeding. The majority of infants in the primary analytic population (77.5%, 186/240) were breastfed. Serious adverse events (SAEs) categorized as “infections and infestations” were

observed in 11.4% (5/44) of infants who were not breastfed, 10.4% (16/154) of infants who were exposed to Xolair through breast-feeding, and 12.5% (4/32) of infants who were breast-fed without exposure to Xolair through breast-feeding. The study has methodological limitations, including a nonrandomized study design.

The developmental and health benefits of breast-feeding should be considered along with the mother's clinical need for Xolair and any potential adverse effects on the breast-fed child from omalizumab or from the underlying maternal condition.

Animal Data

The presence of omalizumab in milk was evaluated in female cynomolgus monkeys receiving subcutaneous doses of 75 mg/kg/week. Neonatal serum levels of omalizumab after *in utero* exposure and 28 days of nursing were between 11% and 94% of the maternal serum level. Milk levels of omalizumab were 0.15% of the maternal serum concentration.

Females and males of reproductive potential

There are no special recommendations for women of child-bearing potential.

Infertility

There are no human fertility data for omalizumab. In specifically-designed non clinical fertility studies in adult cynomolgus monkeys, including mating studies, no impairment of male or female fertility was observed following repeated subcutaneous dosing with omalizumab at dose levels up to 75 mg/kg/week.

OVERDOSAGE

Maximum tolerated dose of Xolair has not been determined. Single intravenous doses up to 4,000 mg have been administered to patients without evidence of dose-limiting toxicities. The highest cumulative dose administered to patients was 44,000 mg over a 20-week period and this dose did not result in any untoward acute effects.

CLINICAL PHARMACOLOGY

Pharmacotherapeutic group ATC

Pharmacotherapeutic group: other systemic drugs for obstructive airway diseases, ATC code: R03DX05.

Pharmacodynamics

General characteristics

Omalizumab is a recombinant DNA-derived humanized monoclonal antibody that selectively binds to human immunoglobulin E (IgE). The antibody is an IgG1 kappa that contains human framework regions with the complementary-determining regions of a murine parent antibody that binds to IgE.

Patients with Allergic Asthma and Nasal Polyps

IgE plays a central effector role in the pathophysiology of inflammatory diseases in the airway. The allergic cascade is initiated when IgE bound to the high affinity IgE receptor, FcεRI, on the surface of mast cells and basophils is cross-linked by allergen. This results in the degranulation of these effector cells and the release of histamines, leukotrienes, cytokines and other mediators. These mediators are causally linked to the pathophysiology of allergic asthma including airway edema, smooth muscle contraction and altered cellular activity associated with the inflammatory process. They also contribute to the signs and symptoms of allergic disease such as bronchoconstriction, mucus production, wheezing, dyspnea, chest tightness, nasal congestion, sneezing, itchy, runny nose and itchy, watery eyes.

Omalizumab binds to IgE and prevents binding of IgE to FcεRI, thereby reducing the amount of free IgE that is available to trigger the allergic cascade. Treatment of atopic subjects with omalizumab resulted in a marked down-regulation of FcεRI receptors. Furthermore, the *in vitro* histamine release from basophils isolated from Xolair treated subjects was reduced by approximately 90% following stimulation with an allergen compared to pre-treatment values. Treatment with Xolair inhibits IgE-mediated inflammation, as evidenced by reduced blood and tissue eosinophils and reduced inflammatory mediators, including IL-4, IL-5, and IL-13 by innate, adaptive and non-immune cells.

Patients with Allergic Asthma

In clinical studies in asthma patients, free IgE levels in serum were reduced in a dose-dependent manner within one hour following the first dose and maintained between doses. Mean decrease in free IgE in serum was greater than 96% using recommended doses. Total IgE levels (i.e., bound and unbound) in serum increased after the first dose due to the formation of omalizumab:IgE complexes which have a slower elimination rate compared with free IgE. At 16 weeks after the first dose, average serum total IgE levels were five-fold higher compared with pre-treatment levels when using standard assays. After discontinuation of Xolair dosing, the Xolair induced increase in total IgE and decrease in free IgE were reversible, with no observed rebound in IgE levels after drug washout. Total IgE levels did not return to pre-treatment levels for up to one year after discontinuation of Xolair.

Patients with Nasal Polyps

In clinical studies in patients with nasal polyps, Xolair treatment led to a reduction in serum free IgE and an increase in serum total IgE levels, similar to the observations in patients with allergic asthma. After repeated dosing every 2 or 4 weeks, with dosage and frequency according to Tables 3 and 4 (see section DOSAGE REGIMEN AND ADMINISTRATION), mean pre-dose serum free IgE levels decreased by approximately 95% and remained stable between 16 and 24 weeks of treatment. Total IgE levels in serum increased due to the formation of omalizumab-IgE complexes, which have a slower elimination rate compared with free IgE. After repeated dosing every 2 or 4 weeks, with dosage and frequency according to Tables 3 and 4 (see section DOSAGE REGIMEN AND ADMINISTRATION), mean pre-dose serum total IgE levels at Week 16 were 3- to 4- fold higher compared with pre-treatment levels, and remained stable between 16 and 24 weeks of treatment.

Patients with Chronic Spontaneous Urticaria (CSU)

There are several theories for the etiology of CSU, including one that suggests an autoimmune origin. Autoimmune antibodies to IgE and its receptor, FcεRI, have been isolated from the serum of some patients with CSU. These autoantibodies can activate basophils or mast cells leading to release of histamine.

One hypothesis for the mechanism of action of omalizumab in CSU is that it lowers free IgE levels in the blood and subsequently in the skin. This leads to down-regulation of surface IgE receptors, thereby decreasing downstream signaling via the FcεRI pathway, resulting in suppressed cell activation and inflammatory responses. As a consequence, the frequency and severity of symptoms of CSU are lessened. Another hypothesis is that lowering circulating free IgE levels leads to a rapid and non-specific desensitization of cutaneous mast cells. Down-regulation of FcεRI may help to sustain the response.

In clinical studies in CSU patients, omalizumab treatment led to a dose-dependent reduction of free IgE and an increase of total IgE levels in serum, similar to the observations in allergic asthma patients. Maximum suppression of free IgE was observed 3 days after the first subcutaneous dose. After repeated dosing once every 4 weeks, pre-dose serum free IgE levels remained stable between 12 and 24 weeks of treatment. Total IgE levels in serum increased after the first dose due to the formation of omalizumab: IgE complexes which have a slower elimination rate compared with free IgE. After repeated dosing once every 4 weeks at 75 mg to 300 mg, average pre-dose serum total IgE levels at week 12 were two- to three-fold higher compared with pre-treatment levels, and remained stable between 12 and 24 weeks of treatment. After discontinuation of Xolair, free IgE levels increased and total IgE levels decreased towards pre-treatment levels over a 16-week treatment-free follow-up period.

Pharmacokinetics

General characteristics

Absorption

After subcutaneous administration, omalizumab is absorbed with an average absolute bioavailability of 62%. The pharmacokinetics of omalizumab are linear at doses greater than 0.5 mg/kg.

Administration of Xolair manufactured as a lyophilized or liquid formulation resulted in similar serum concentration-time profiles of omalizumab.

Distribution

In vitro, omalizumab forms complexes of limited size with IgE. Precipitating complexes and complexes larger than one million Daltons in molecular weight are not observed *in vitro* or *in vivo*.

Tissue distribution studies in cynomolgus monkeys showed no specific uptake of ¹²⁵I-omalizumab by any organ or tissue.

Elimination

Clearance of omalizumab involves IgG clearance processes as well as clearance via specific binding and complex formation with its target ligand, IgE. Liver elimination of IgG includes degradation in the liver reticuloendothelial system (RES) and endothelial cells. Intact IgG is also excreted in bile. In studies with mice and monkeys, omalizumab:IgE complexes were

eliminated by interactions with Fcγ receptors within the RES at rates that were generally faster than IgG clearance.

Patients with Allergic Asthma

Absorption

Following a single subcutaneous dose in adult and adolescent patients with asthma, omalizumab was absorbed slowly, reaching peak serum concentrations after an average of 7 to 8 days. Following multiple doses of omalizumab, areas under the serum concentration-time curve from Day 0 to Day 14 at steady state were up to 6-fold of those after the first dose.

Distribution

The apparent volume of distribution of omalizumab in patients with asthma following subcutaneous administration was 78 ± 32 mL/kg.

Elimination

In asthma patients omalizumab serum elimination half-life averaged 26 days, with apparent clearance averaging 2.4 ± 1.1 mL/kg/day. Doubling of body weight approximately doubled apparent clearance.

Age, Race/Ethnicity, Gender, Body Mass Index

The population pharmacokinetics of omalizumab were analysed to evaluate the effects of demographic characteristics. Analyses of these data suggest that no dose adjustments are necessary in asthma patients for age (6 to 76 years), race, ethnicity, gender or body mass index.

Patients with Nasal Polyps

The population pharmacokinetics analyses of omalizumab suggested that pharmacokinetics of omalizumab in nasal polyps were consistent with that in asthma. Graphical covariate analyses were performed to evaluate the effects of demographic characteristics and other factors on omalizumab exposure and clinical responses. These analyses demonstrate that no dose adjustments are necessary for age (18 to 75 years) or gender. Race and ethnicity data are too limited in nasal polyps to inform dose adjustment.

Patients with Chronic Spontaneous Urticaria (CSU)

Absorption

Following a single subcutaneous dose in adult and adolescent patients with CSU, omalizumab was absorbed slowly, reaching peak serum concentrations after an average of 6 to 8 days.

In patients with CSU, omalizumab exhibited linear pharmacokinetics across the dose range of 75 mg to 600 mg given as a single subcutaneous dose. Following doses of 75 mg, 150 mg or 300 mg every 4 weeks, trough serum concentrations of omalizumab increased proportionally with the dose level.

Distribution

Based on population pharmacokinetic, distribution of omalizumab in CSU patients was similar to that in patients with allergic asthma.

Elimination

In patients with CSU, based on population pharmacokinetic simulations, omalizumab serum elimination half-life at steady state averaged 24 days and apparent clearance at steady state averaged 240 mL/day (corresponding to 3.0 mL/kg/day for an 80 kg patient).

Age, Race/Ethnicity, Gender, Body Weight, Body Mass Index, Baseline IgE, anti-FcεRI autoantibodies, co-medications

The effects of demographic covariates and other factors on omalizumab exposure were evaluated using population pharmacokinetics. In addition, covariate effects were evaluated by analyzing the relationship between omalizumab concentrations and clinical responses. These analyses suggest that no dose adjustments are necessary in patients with CSU for age (12 to 75 years), race/ethnicity, gender, body weight, body mass index, baseline IgE, anti-FcεRI autoantibodies or concomitant use of H2 antihistamines or leukotriene receptor antagonists (LTRAs).

Patients with renal or hepatic impairment

There are no pharmacokinetic or pharmacodynamic data in patients with renal or hepatic impairment in allergic asthma and CSU patients (see section WARNINGS AND PRECAUTIONS).

CLINICAL STUDIES

Allergic Asthma

Adults and adolescents ≥12 years of age

The safety and efficacy of Xolair were evaluated in five randomized, double-blind, placebo controlled, multi-center trials.

In identical 16-week studies 1 and 2, the safety and efficacy of omalizumab as add-on therapy were demonstrated in 1,071 allergic asthmatics, who were symptomatic despite treatment with inhaled corticosteroids (beclomethasone dipropionate 500 to 1,200 micrograms/day).

In both trials omalizumab was superior to placebo with respect to the primary variable of asthma exacerbation (worsening of asthma requiring systemic corticosteroids or a doubling of the patient's baseline beclomethasone dose). The number of asthma exacerbations was significantly lower in the omalizumab group ($p=0.006$ and $p<0.001$ in studies 1 and 2, respectively). Fewer omalizumab-treated patients experienced asthma exacerbations (14.6% vs 23.3%, $p=0.009$ in study 1 and 12.8% vs 30.5%, $p<0.001$ in study 2).

In double-blind extension phases of both studies out to one year the reduction in the frequency of asthma exacerbations for omalizumab-treated patients compared to placebo-treated patients was maintained.

In studies 1 and 2, clinically meaningful improvement in asthma-related quality of life, measured by the validated Juniper's Asthma Quality of Life Questionnaire, was demonstrated in the Xolair group at the end of the 28-week core trial compared to that observed in the placebo treated group (difference from placebo $p\leq 0.001$ in studies 1 and 2).

In study 3 the safety and corticosteroid-sparing effect of omalizumab was demonstrated in 246 patients with severe allergic asthma requiring daily treatment with high-dose inhaled corticosteroids (fluticasone $\geq 1,000$ micrograms/day) and in whom long-acting beta2-agonists were allowed. The study included a 16-week steroid stable phase with study medication added, followed by a 16-week steroid reduction phase. The percent reduction in inhaled corticosteroid dose at the end of the treatment phase was significantly greater in omalizumab-treated patients versus placebo patients (median 60% vs. 50%, $p=0.003$). The proportion of omalizumab patients who were able to reduce their fluticasone dose to ≤ 500 micrograms/day was 60.3% versus 45.8% in the placebo group.

In study 4 the safety and efficacy of omalizumab were demonstrated in 405 patients with comorbid allergic asthma and perennial allergic rhinitis. Eligible patients had both symptomatic allergic asthma and perennial allergic rhinitis. Patients were treated with omalizumab or placebo for 28 weeks as add-on therapy to ≥ 400 micrograms of Budesonide Turbohaler. Inhaled long-acting beta2-agonists (39%) and nasal corticosteroids (17%) were allowed.

The co-primary endpoints for study 4 were the incidence of asthma exacerbations (worsening of asthma requiring systemic corticosteroids or a doubling of the patient's baseline budesonide dose) and the proportion of patients in each treatment group with a ≥ 1.0 improvement from baseline at the end of the treatment phase in both asthma and rhinitis specific quality of life assessments (Juniper Quality of Life Assessment).

Patients treated with omalizumab had a significantly lower incidence of asthma exacerbations than patients receiving placebo (20.6% omalizumab vs 30.1% placebo, $p=0.02$) and there was a significantly higher proportion of omalizumab-treated than placebo patients that improved by ≥ 1.0 points in both asthma and rhinitis specific quality of life assessments (57.7% omalizumab vs 40.6% placebo, $p < 0.0001$).

The reduction in exacerbations and improvements of quality of life in omalizumab-treated patients were seen in the context of statistically significant improvements in both rhinitis and asthma symptoms, and lung function, compared to placebo.

In study 5 the efficacy and safety of Xolair were demonstrated in a 28-week study involving 419 severe allergic asthmatics, ages 12 to 79 years, who had reduced lung function (Forced Expiratory Volume/1 second: FEV₁ 40 to 80% predicted) and poor asthma symptom control despite receiving $>1,000$ micrograms of beclomethasone dipropionate (or equivalent) plus long-acting beta2-agonist. Eligible patients had experienced multiple asthma exacerbations requiring systemic corticosteroid treatment or had been hospitalised or attended an emergency room due to a severe asthma exacerbation in the past year despite continuous treatment with high-dose inhaled corticosteroids and long-acting beta2-agonist. Subcutaneous Xolair or placebo were administered as add-on therapy to $>1,000$ micrograms beclomethasone dipropionate (or equivalent) plus long-acting beta2-agonist. Oral corticosteroid (22%), theophylline (27%) and anti-leukotriene (35%) maintenance therapies were allowed. In the treatment phase concomitant asthma therapy was not changed.

The rate of asthma exacerbations requiring treatment with bursts of systemic corticosteroids was the primary endpoint. Omalizumab reduced the rate of asthma exacerbations by 19% ($p = 0.153$). Further evaluations which did show statistical significance ($p < 0.05$) in favour of Xolair included reductions in severe exacerbations (where patient's lung function was reduced to below 60% of personal best and requiring systemic corticosteroids) and asthma-related emergency visits (comprised of hospitalisations, emergency room, and unscheduled doctor visits), and improvements in Physician's overall assessment of treatment effectiveness,

Asthma-related Quality of Life (AQL), asthma symptoms and lung function. A physician's overall assessment was performed in the five above mentioned studies as a broad measure of asthma control performed by the treating physician. The physician was able to take into account Peak Expiratory Flow (PEF), day and night time symptoms, rescue medication use, spirometry and exacerbations. In all five studies a significantly greater proportion of Xolair treated patients were judged to have achieved either a marked improvement or complete control of their asthma compared to placebo patients.

Children 6 to <12 years of age

The primary support for safety and efficacy of Xolair in the 6 to <12 years of age group comes from one randomized, double-blind, placebo controlled, multi-center trial (study 6) and an additional supportive study (study 7).

Study 6 was a 52 week study that evaluated the safety and efficacy of Xolair as add-on therapy in 628 allergic asthmatics who were uncontrolled despite treatment with regular inhaled corticosteroids (fluticasone DPI ≥ 200 mcg/day or equivalent) with or without other controller asthma medications. Eligible patients were those with a diagnosis of asthma >1 year and a positive skin prick test to at least one perennial aeroallergen and a history of clinical features of moderate to severe persistent asthma including daytime and/or night-time symptoms along with a history of experiencing exacerbations within the year prior to study entry. Long-acting beta2-agonists (67.4%), anti-leukotriene (36.6%) and oral corticosteroid (1.3%) maintenance therapies were allowed. During the first 24 weeks of treatment, a patient's steroid doses remained constant from baseline and this was followed by a 28 week period during which inhaled corticosteroid adjustment was allowed.

A clinically significant exacerbation was defined as a worsening of asthma symptoms as judged clinically by the investigator, requiring doubling of the baseline inhaled corticosteroid dose for at least 3 days and/or treatment with rescue systemic (oral or IV (intravenous)) corticosteroids for at least 3 days.

Exacerbation rates during the 52-week double-blind treatment period in Xolair patients with FEV₁ >80% at baseline had relative decreases of 43% in asthma exacerbations compared with placebo (p<0.001). Xolair patients had statistically significant reduction in the rate of asthma exacerbations irrespective of concomitant long-acting beta2-agonist use at baseline compared with placebo patients, representing a 45% decrease for long-acting beta2-agonist users and a 42% decrease for long-acting beta2-agonist non-users (p<0.001 and p=0.011, respectively).

Study 7 was a 28 week randomized, double blind, placebo-controlled study primarily evaluating safety in 334 children, aged 6 to 12 years of age, with asthma who were well controlled with inhaled corticosteroids. During the first 16 weeks of treatment, patients' steroid doses remained constant from baseline and this was followed by a 12 week steroid dose reduction period. The study assessed percent reduction in the dose of beclomethasone dipropionate (BDP) and the proportion of patients with a reduction in the dose of BDP at 28 weeks. The percent reduction in the dose of BDP at 28 weeks was higher in the Xolair group than in the placebo group (median reduction 100% vs. 66.7%, p=0.001) as well as the proportion of patients with a reduction in the dose of BDP (p=0.002). Frequency and incidence of asthma exacerbation episodes during the steroid dose-reduction phase were also lower in the omalizumab group (mean rate 0.42 vs. 0.72, p<0.001; percent patients with exacerbations 18% vs. 39%, p<0.001). A trend for superiority of omalizumab with respect to reduction of exacerbation frequency and incidence was evident during the first 16 weeks of the 24 week treatment period. 55.7% of

omalizumab patients had a complete (100%) reduction in corticosteroid dose at the end of the 28 week treatment period compared with 43.2% of placebo patients. In addition, more omalizumab patients had a $\geq 50\%$ reduction in corticosteroid dose compared with placebo (80.4% vs. 69.5%. $p=0.017$).

A physician's overall assessment was performed in the two above mentioned studies (6 and 7) as a broad measure of asthma control performed by the treating physician. The physician was able to take into account PEF, day and night time symptoms, rescue medication use, spirometry and exacerbations. In both studies a significantly greater proportion of Xolair treated patients were judged to have achieved either a marked improvement or complete control of their asthma compared to placebo patients.

Nasal Polyps

The safety and efficacy of Xolair were evaluated in two randomized, multicenter, double-blind, placebo-controlled clinical trials that enrolled patients with chronic rhinosinusitis with nasal polyps (study 1, N=138; study 2, N=127). Patients received Xolair or placebo subcutaneously every 2 or 4 weeks, with dosage and frequency according to Tables 3 and 4 (see section DOSAGE REGIMEN AND ADMINISTRATION). All patients received background intranasal mometasone therapy throughout the study. Prior sino-nasal surgery or prior systemic corticosteroid usage were not required for inclusion in the studies. Patients received Xolair or placebo for 24 weeks followed by a 4-week follow-up period. Demographics and baseline characteristics, including allergic comorbidities, are described in Table 8.

Table 8 Demographics and baseline characteristics of Nasal Polyps Studies

Parameter	Nasal Polyp Study 1 N=138	Nasal Polyp Study 2 N=127
Mean age (years) (SD)	51.0 (13.2)	50.1 (11.9)
% Male	63.8	65.4
Patients with systemic corticosteroid use in the previous year (%)	18.8	26.0
Mean bilateral endoscopic NPS* (SD), range 0-8	6.2 (1.0)	6.3 (0.9)
Mean nasal congestion (NC) score* (SD), range 0-3	2.4 (0.6)	2.3 (0.7)
Mean sense of smell score* (SD) range 0-3	2.7 (0.7)	2.7 (0.7)
Mean SNOT-22 total score* (SD) range 0-110	60.1 (17.7)	59.5 (19.3)
Mean blood eosinophils (cells/ μ l) (SD)	346.1 (284.1)	334.6 (187.6)
Mean total IgE IU/mL (SD)	160.9 (139.6)	190.2 (200.5)
Asthma (%)	53.6	60.6
Mild (%)	37.8	32.5
Moderate (%)	58.1	58.4
Severe (%)	4.1	9.1
Aspirin exacerbated respiratory disease (%)	19.6	35.4
Allergic rhinitis	43.5	42.5

SD=standard deviation; NPS=nasal polyp score; SNOT-22 = Sino-Nasal Outcome Test 22 Questionnaire; IgE = Immunoglobulin E; IU=international units. For NPS, NCS, sense of smell, post nasal drip, runny nose, and SNOT-22 scores higher scores indicate greater disease severity

The co-primary endpoints were bilateral nasal polyp score (NPS) and average daily nasal congestion score (NCS) at Week 24. NPS was measured via endoscopy at baseline and pre-specified time points and scored (range 0-4 per nostril) for a total NPS (range 0/best-8/worst).

Nasal congestion was measured by a daily NCS (range 0/best-3/worst). Patients were required to have NPS ≥ 5 and weekly average of NCS > 1 prior to randomization, despite use of intranasal mometasone. The mean NPS at baseline was balanced between the two treatment groups in both studies.

In both nasal polyps studies 1 and 2, patients who received Xolair had a statistically significant greater improvement from baseline at Week 24 in NPS and weekly average NCS than patients who received placebo. Results from Nasal Polyps Study 1 and 2 are shown in Table 9.

The greater improvements in NPS and NCS in the Xolair group compared to the placebo group were observed as early as the first assessment at Week 4 in both studies as seen in Figure 1. The LS mean difference in change from baseline at Week 4 in NPS in Xolair compared to placebo was -0.92 (95% CI: -1.37, -0.48) in study 1 and -0.52 (95% CI: -0.94, -0.11) in study 2. The LS mean difference in change from baseline at Week 4 in NCS in Xolair compared to placebo was -0.25 (95% CI: -0.46, -0.04) in study 1 and -0.26 (95% CI: -0.45, -0.07) in study 2. However, statistical tests at this time point were not pre-specified.

Table 9 Change from baseline at Week 24 in nasal polyp score and 7-day average of daily nasal congestion score in Nasal Polyp Study 1 and Nasal Polyp Study 2

	Nasal Polyp Study 1		Nasal Polyp Study 2	
	Placebo	Xolair	Placebo	Xolair
N	66	72	65	62
Nasal polyp score				
Baseline mean	6.32	6.19	6.09	6.44
LS mean change at Week 24	0.06	-1.08	-0.31	-0.90
Difference in LS means vs. placebo		-1.14		-0.59
95% CI for difference		-1.59, -0.69		-1.05, -0.12
p-value		<0.0001		0.0140
7-day average of daily nasal congestion score				
Baseline mean	2.46	2.40	2.29	2.26
LS mean change at week 24	-0.35	-0.89	-0.20	-0.70
Difference in LS means vs. placebo		-0.55		-0.50
95% CI for difference		-0.84, -0.25		-0.80, -0.19
p-value		0.0004		0.0017

LS=least-square

Figure 1 Mean change from baseline in nasal congestion score and mean change from baseline in nasal polyp score by treatment group in Nasal Polyp Study 1 and Nasal Polyp Study 2

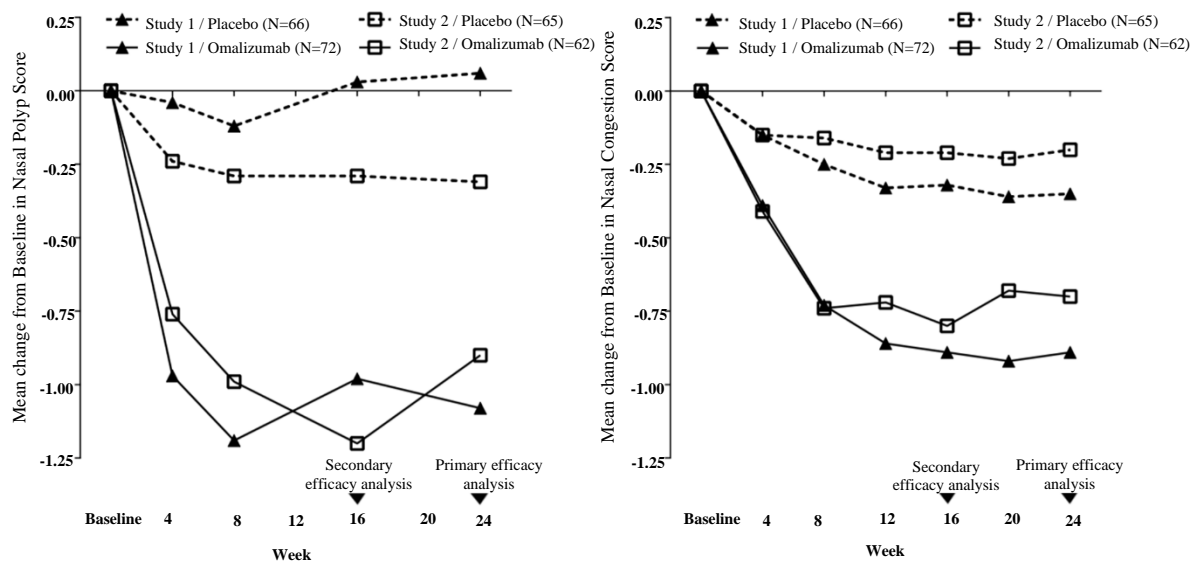

A key secondary endpoint was the assessment of the change from baseline at Week 24 of the total nasal symptom score (TNSS). Patient-reported TNSS was the sum of four equally weighted individual daily symptom scores: NCS, sense of smell score, posterior rhinorrhea score, and anterior rhinorrhea score. The TNSS ranged from 0/best-12/worst. Xolair significantly improved the average daily TNSS compared to placebo. The LS mean difference for change from baseline to Week 24 was -1.91 points (95% CI: -2.85, -0.96; $p = 0.0001$) in study 1 and -2.09 points (95% CI: -3.00, -1.18; $p < 0.0001$) in study 2.

Xolair significantly improved SNOT-22 (Sino-Nasal Outcome Test), which combines measures of sino-nasal symptoms with psychological and sleep dysfunction measures. The SNOT-22, ranged from 0 to 110 (0/best-110/worst). The LS mean difference for change from baseline to Week 24 in SNOT-22 in Xolair compared to placebo was -16.12 (95% CI: -21.86, -10.38; $p < 0.0001$) in study 1 and -15.04 (95% CI: -21.26, -8.82; $p < 0.0001$) in study 2.

Xolair also significantly improved the average daily UPSIT (University of Pennsylvania Sell Identification Test) compared to placebo. The UPSIT ranged from 0 to 40 (0/worst-40/best). The LS mean difference for change from baseline to Week 24 in Xolair compared to placebo was 3.81 points (95% CI: 1.38, 6.24; $p = 0.0024$) in study 1 and 3.86 points (95% CI: 1.57, 6.15; $p = 0.0011$) in study 2.

The effect on TNSS and SNOT-22 was observed as early as the first assessment at week 4 in both studies. Additionally, the effect on UPSIT was observed at the first assessment at week 8 in both studies. The LS mean difference for change from baseline at Week 4 in TNSS in Xolair compared to placebo was -0.97 (95% CI: -1.61, -0.33) in study 1 and -1.18 (95% CI: -1.76, -0.59) in study 2. The LS mean difference in change from baseline at Week 4 in SNOT-22 in Xolair compared to placebo was -10.43 (95% CI: -15.08, -5.79) in study 1 and -8.84 (95% CI: -13.84, -3.84) in study 2. The LS mean difference in change from baseline at Week 8 in UPSIT in Xolair compared to placebo was 3.72 (95% CI: 1.54, 5.90) in study 1 and 5.12 (95% CI: 2.57, 7.67) in study 2. These analyses were not pre-specified.

Additional secondary endpoint analyses included Week 16 assessments of NPS and NCS. Xolair significantly improved the NPS at week 16, (range 0/best-8/worst) compared to placebo.

The LS mean difference for change from baseline to Week 16 in Xolair compared to placebo was -1.01 (95% CI: -1.43, -0.60; $p < 0.0001$) in study 1 and -0.91 (95% CI: -1.39, -0.44; $p = 0.0002$) in study 2. Xolair significantly improved the NCS at week 16, (range 0/best-3/worst) compared to placebo. The LS mean difference for change from baseline to Week 16 in average daily NCS in Xolair compared to placebo was -0.57 (95% CI: -0.83, -0.31; $p < 0.0001$) in study 1 and of -0.59 (95% CI: -0.87, -0.30; $p < 0.0001$) in study 2.

In a pre-specified pooled analysis of rescue treatment (systemic corticosteroids for ≥ 3 consecutive days or nasal polypectomy) during the 24-week treatment period, the proportion of patients requiring rescue treatment was lower in Xolair compared to placebo (2.3% versus 6.2%, respectively). The odds-ratio of having taken rescue treatment in Xolair compared to placebo was 0.38 (95% CI: 0.10, 1.49). There were no sino-nasal surgeries reported in either study.

The long-term efficacy and safety of Xolair in patients with chronic rhinosinusitis with nasal polyps who had participated in nasal polyp studies 1 and 2 was assessed in an open-label extension study. Efficacy data from this study suggest that clinical benefit provided at Week 24 was sustained through to Week 52. Safety data were overall consistent with the known safety profile of Xolair.

Chronic Spontaneous Urticaria (CSU)

The clinical Phase III development program for CSU included three randomized, double-blind, placebo controlled, parallel-group, multicenter studies: Q4881g, Q4882g and Q4883g.

Studies Q4881g and Q4882g evaluated efficacy and safety of administration of 75 mg, 150 mg, or 300 mg Xolair every 4 weeks for 24 and 12 weeks respectively, with a 16-week treatment-free follow-up period in patients (12 to 75 years) with refractory CSU despite H1 antihistamine treatment.

Study Q4883g evaluated safety and efficacy of 300 mg Xolair administered every 4 weeks for 24 weeks, with a 16-week treatment-free follow-up period in patients (12 to 75 years) with refractory CSU despite H1 and/or H2 antihistamine and/or leukotriene receptor antagonist (LTRA) treatment.

Table 10 Efficacy endpoints in Studies Q4881g, Q4882g and Q4883g

Change from baseline to week 12 in weekly Itch Severity Score (ISS, range 0-21)	Primary endpoint in studies Q4881g and Q4882g Secondary endpoint in safety study Q4883g
Time to MID ^a response (decrease from baseline of ≥ 5 points) in weekly itch severity score (ISS) up to week 12	Secondary endpoints in all three studies Q4881g, Q4882g and Q4883g
Change from Baseline to week 12 in Urticaria Activity score during a 7 day period (UAS7 ^b , range 0-42)	
Proportion of patients with Urticaria Activity Score during a 7-Day Period ≤ 6 (UAS7 ^b ≤ 6) at week 12	
Proportion of patients with Urticaria Activity Score during a 7-Day Period = 0 (UAS7 ^b = 0) at week 12 ^c	
Changes from baseline in the weekly number of hives score at week 12	
Change from baseline to week 12 in overall Dermatology Life Quality Index (DLQI)	
Proportion of patients with angioedema-free days from week 4 to week 12 ^d	

^a MID: Minimally Important Difference

^b UAS7: Composite of itch severity and number of hives measured daily and totalled over one week

^c Post hoc analysis for study Q4882g

^d Mean proportion of angioedema-free days from week 4 to week 12 was calculated for the entire study population, including patients asymptomatic for angioedema.

In studies Q4881g and Q4882g the 75 mg dose did not consistently meet either the primary efficacy endpoint (change from baseline to week 12 in weekly itch severity score) or a number of secondary endpoints. It was deemed not efficacious and therefore not further presented.

Change from baseline to week 12 in weekly itch severity score

The primary efficacy endpoint, change from baseline to week 12 in weekly itch severity score was met by both the 150 mg and 300 mg doses in studies Q4881g and Q4882g and by the 300 mg dose in Q4883g (secondary endpoint: see Table 11).

Table 11 Change from baseline to week 12 in weekly itch severity score, Studies Q4881g, Q4882g and Q4883g (mITT population*)

	Placebo	Omalizumab 150mg	Omalizumab 300mg
Study Q4881g			
N	80	80	81
Mean (SD)	-3.63 (5.22)	-6.66 (6.28)	-9.40 (5.73)
Difference in LS means vs. placebo ¹	-	-2.95	-5.80
95% CI for difference	-	-4.72, -1.18	-7.49, -4.10
P-value vs. placebo ²	-	0.0012	<0.0001
Study Q4882g			
N	79	82	79
Mean (SD)	-5.14 (5.58)	-8.14 (6.44)	-9.77 (5.95)
Difference in LS means vs. placebo ¹	-	-3.04	-4.81
95% CI for difference	-	-4.85, -1.24	-6.49, -3.13
P-value vs. placebo ²	-	0.0011	<0.0001
Study Q4883g			
N	83	-	252
Mean (SD)	-4.01 (5.87)	-	-8.55 (6.01)
Difference in LS means vs. placebo ¹	-	-	-4.52
95% CI for difference	-	-	-5.97, -3.08
P-value vs. placebo ²	-	-	<0.0001

*Modified intent-to-treat (mITT) population: Included all patients who were randomized and received at least one dose of study medication.

BOCF (Baseline Observation Carried Forward) was used to impute missing data.

¹ The LS mean was estimated using an ANCOVA model. The strata were baseline weekly itch severity score (< 13 vs. ≥13) and baseline weight (< 80 kg vs. ≥ 80 kg).

² p-value is derived from ANCOVA t-test

Figure 2 shows the mean weekly itch severity score over time in study Q4881g. The mean weekly itch severity scores significantly decreased in both treatment groups with a maximum effect around week 12 that was sustained over the 24-week treatment period. In studies Q4883g (300 mg over the 24-week treatment period) and Q4882g (150 mg and 300 mg over the 12-week treatment period) the results were similar to those of study Q4881g.

In all three studies (see Figure 2 for study Q4881g), the mean weekly itch severity score for both doses increased gradually during the 16-week treatment-free follow-up period, consistent

with symptom re-occurrence. Mean values at the end of the follow-up period were similar to the placebo group, but lower than respective mean baseline values.

Figure 2 Mean weekly itch severity score over time, Study Q4881g (BOCF, mITT population)

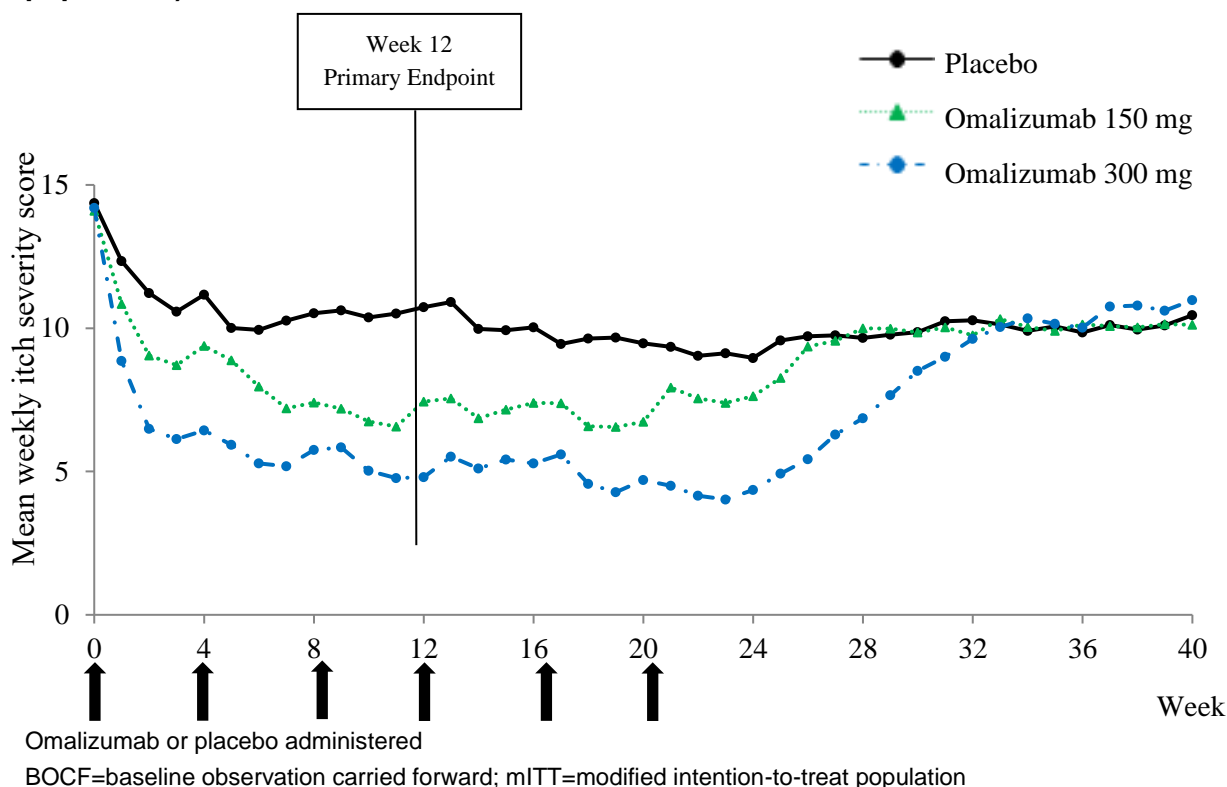

Time to Minimal Important Difference (MID) response of 5 points in weekly ISS up to week 12

In studies Q4881g and Q4882g the times to attain MID of 5 points on the weekly itch severity score were statistically significantly shorter for patients in the 300 mg treatment groups, compared to the placebo groups with p-value < 0.0001. A shorter time was also observed for the 150 mg treatment groups compared to placebo with p=0.0301 in study Q4881g and p=0.0101 in study Q4882g. The median times for attaining MID response were 1 week in the 300 mg treatment group, 2 weeks in the 150 mg groups and 4 weeks for placebo.

Similar results were observed in study Q4883g with p<0.0001 (median time to MID response was 2 weeks in the 300 mg treatment group and 5 weeks in the placebo group).

Change from baseline to week 12 in UAS7

In the phase III studies the omalizumab 150 mg and 300 mg treatment groups showed a statistically significant difference from placebo in mean change from baseline to week 12 in UAS7 (Figure 3 for study Q4881g). Statistical significance (p<0.0001) was achieved in all three studies for the 300 mg treatment group, and in studies Q4881g (p=0.0008) and Q4882g (p=0.0001) for the 150 mg treatment group.

Figure 3 shows mean UAS7 over time in study Q4881g, displaying a significant decrease from baseline in both treatment groups with a maximum effect around week 12. The magnitude of the effect was maintained during the 24-week treatment period. In studies Q4882g (150 mg and

300 mg over the 12-week treatment period) and Q4883g (300 mg over 24-week treatment period) the results were similar to those of study Q4881g.

In all three studies (see Figure 3 for study Q4881g), the UAS7 for both omalizumab treatment groups increased gradually during the 16-week treatment-free follow-up period, consistent with symptom re-occurrence. Mean values at the end of the follow-up period were similar to the placebo group but lower than respective mean baseline values.

Figure 3 Mean UAS7 over time, Study Q4881g (BOCF, mITT population)

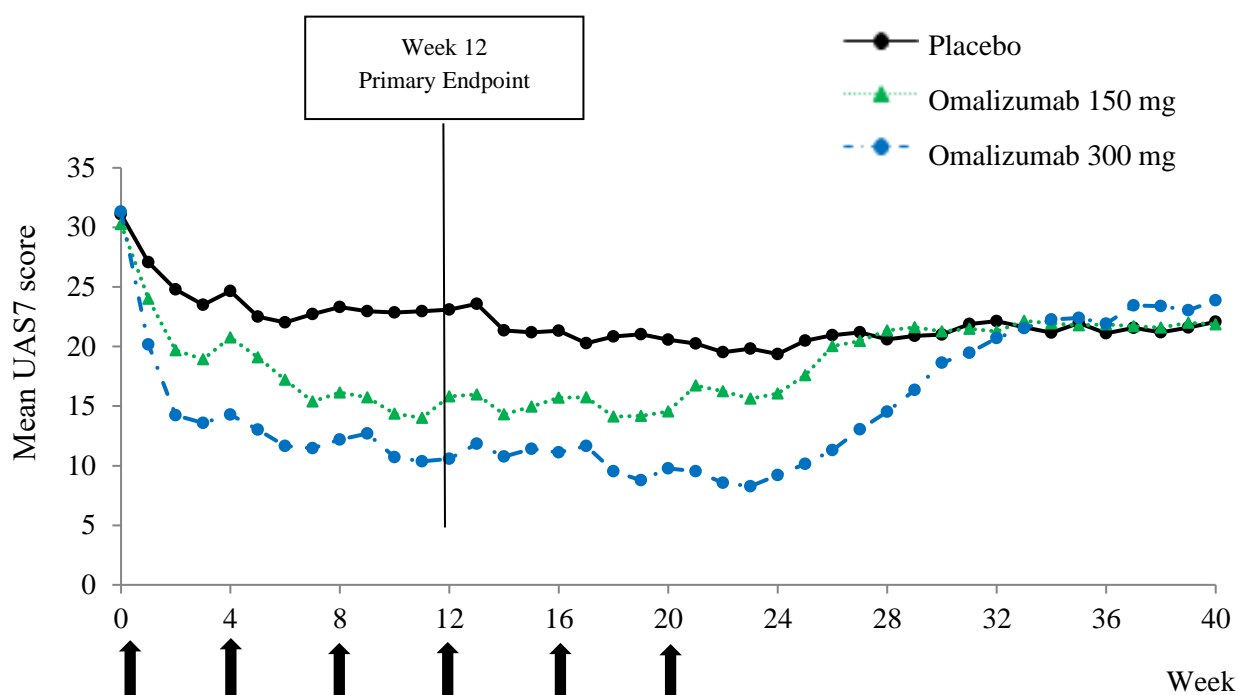

Omalizumab or placebo administered

BOCF=baseline observation carried forward; mITT=modified intention-to-treat population; UAS7= urticaria activity score over 7 days

Proportion of patients with UAS7 ≤ 6 at week 12

The response rates for UAS7 ≤ 6 at week 12 were ranging from 52- 66% for the 300 mg treatment groups (51.9% in Q4881g, 65.8% in Q4882g and 52.4% in Q4883g) were all statistically significantly higher compared to 11-19% for the placebo groups (11.3% in Q4881g, 19.0% in Q4882g and 12.0% in Q4883g; all p<0.0001). In the 150 mg treatment groups, the proportion of patients with UAS7≤ 6 at week 12 ranging from 40 - 43% (40.0% in Q4881g, 42.7% in Q4882g) showed a clinically notable difference to the placebo groups (11.3% and 19.0%; p<0.0001 and p=0.0010, respectively).

The proportions of patients with a UAS7 ≤6 at week 12 are shown in Figure 4. The response rates ranged from 52 to 66% (300 mg dose; p<0.0001), all were statistically significantly higher compared to 11-19% in the placebo group. The response rates for the 150 mg dose show a notable difference (40 to 43%; p≤0.001) compared to placebo.

Figure 4 Proportion of patients with UAS7 ≤6 at week 12, Studies Q4881g, Q4882g and Q4883g

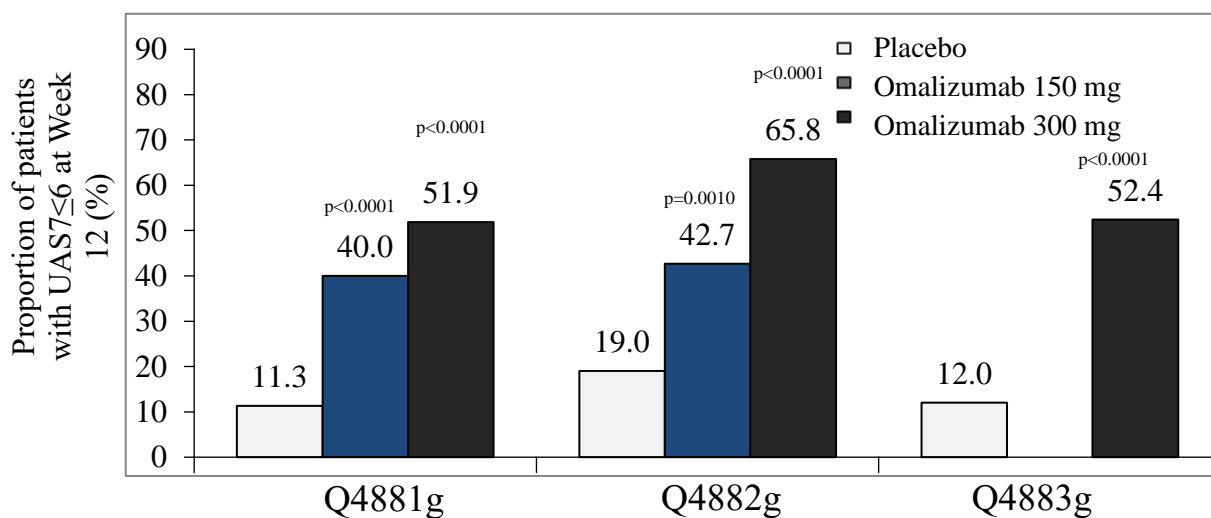

p-values are omalizumab vs placebo group

Proportion of patients with UAS7 = 0 at week 12

The proportion of patients with a complete response, defined by a UAS7 = 0 at week 12, was statistically significant for the 300 mg treatment groups compared to placebo, ranging from 34 to 44% (35.8% in Q4881g, 44.3% in Q4882g, and 33.7% in Q4883g, versus 8.8% in Q4881g, 5.1% in Q4882g and 4.8% in Q4883g with placebo; all p<0.0001). It was numerically better for the 150 mg treatment groups, with 15.0% in Q4881g and 22.0% in Q4882g compared to placebo.

The proportion of patients with a complete response shown by a UAS7 = 0 at week 12 ranged from 34 to 44% (300 mg dose, statistically significant, all p<0.0001) compared to 5 to 9% in the placebo groups. In the 150 mg treatment groups, a clinically notable difference compared to placebo was observed ranging from 15 to 22% (Figure 5).

Figure 5 Proportion of patients with UAS7 = 0 at week 12, Studies Q4881g, Q4882g and Q4883g

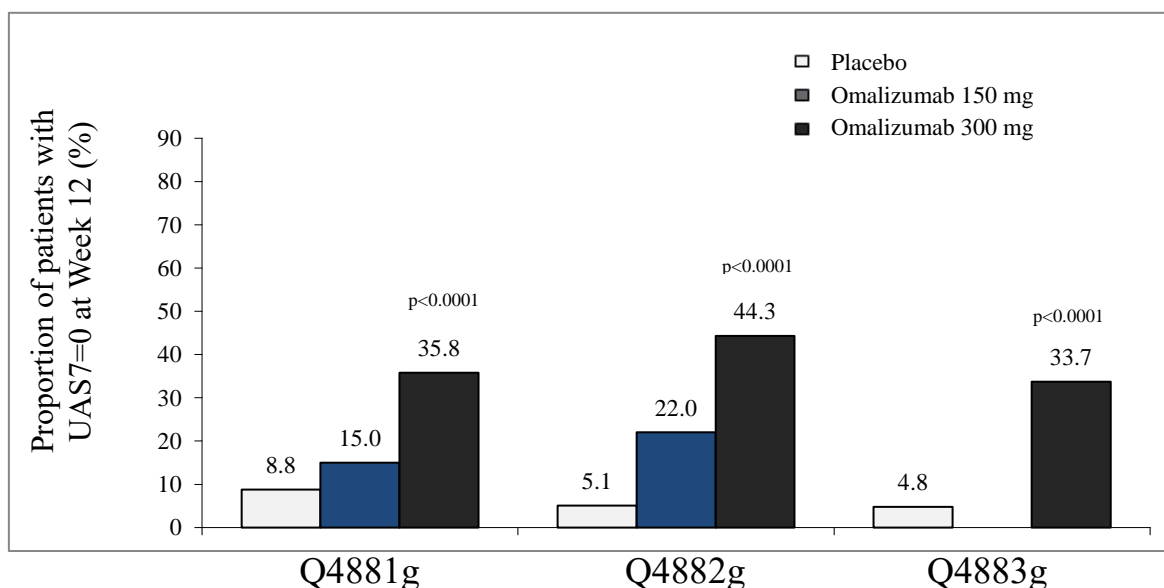

p-values are omalizumab vs placebo group

Prospective analysis in studies Q4881g and Q4883g, and as post-hoc analysis in study Q4882g

Changes from baseline in the weekly number of hives score at week 12

In all three phase III studies, the difference from placebo in mean changes from baseline in the weekly number of hives score at week 12 for the 300 mg treatment groups was statistically significant displaying a decrease in number of hives score compared to placebo (-11.35 in Q4881g, -11.97 in Q4882g and -10.46 in Q4883g versus -4.37, -5.22 and -4.49 for the corresponding placebo groups; all $p < 0.0001$). For the 150 mg treatment groups, the mean changes were -7.78 ($p = 0.0017$) in Q4881g and -9.75 ($p < 0.0001$) in Q4882g.

Proportion of angioedema-free days from week 4 to week 12

In all three phase III studies the 300 mg treatment groups consistently achieved the highest mean proportion of angioedema-free days from week 4 to week 12 (96.1% in Q4881g; 95.5% in Q4882g; 91% in Q4883g) compared to the placebo group (88.2%, 89.2%, 88.1%, respectively; all $p < 0.001$). In the 150 mg treatment groups, the mean proportions of angioedema-free days for the same time period for studies Q4881g and Q4882g were 89.6% and 91.6% respectively, with no statistically significant difference to placebo. In all three Phase III studies the 300 mg treatment groups consistently achieved the highest mean proportion of angioedema-free days from week 4 to week 12 (91 to 96%). The increase in the proportion of angioedema-free days compared to placebo was statistically significant ($p < 0.001$) (Fig 6). In the 150 mg treatment group, the mean proportions of angioedema-free days for the same time period for studies Q4881g and Q4882 were 89.6% and 91.6% respectively. The corresponding placebo values for the same studies were 88.2% and 89.2%. In both of these studies, the differences from placebo did not achieve statistical significance for the 150 mg dose.

Figure 6 Proportion of angioedema-free days from week 4 to week 12, Studies Q4881g, Q4882g and Q4883g

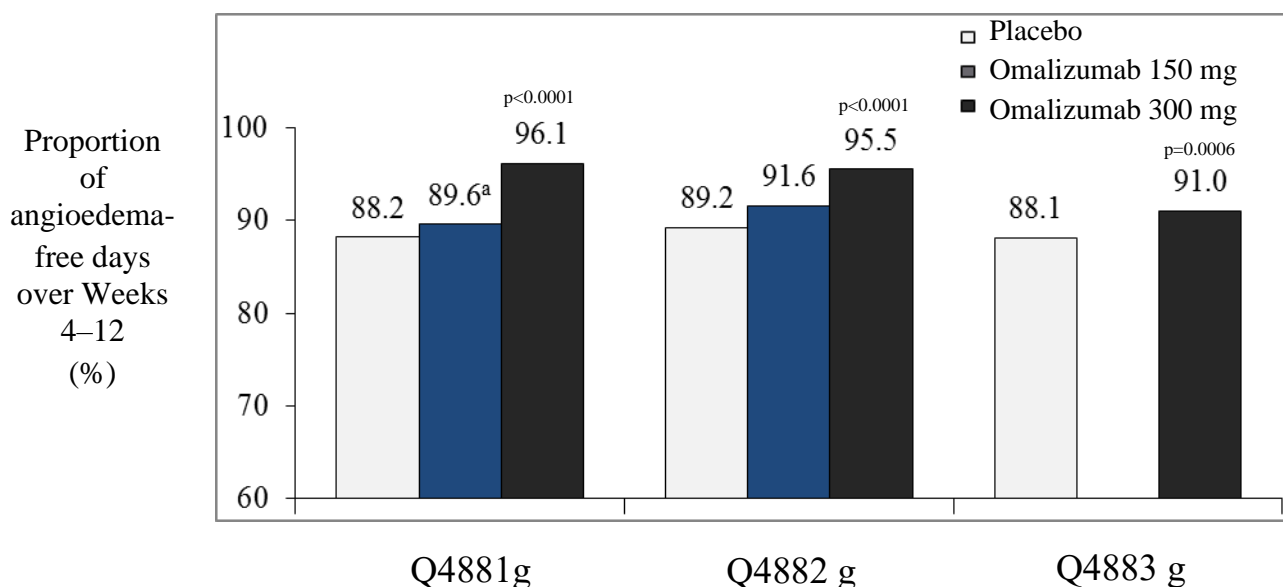

p values are omalizumab vs placebo group

^aNot evaluated for statistical significance in accordance with the type I error control plan

The mean proportion of angioedema-free days from week 4 to week 12 was calculated for the entire study population, including those patients asymptomatic for angioedema.

Change from baseline to week 12 in overall Dermatology Life Quality Index (DLQI)

In all three phase III studies, the mean change from baseline to week 12 in the overall DLQI for the 300 mg treatment groups was statistically significantly greater than placebo showing an improvement of 10.3 points in Q4881g, 10.2 in Q4882g and 9.7 in Q4883g versus 6.1, 6.1, and 5.1 for the corresponding placebo groups (all $p < 0.001$). For the 150 mg treatment groups, the mean changes were 8.0 points ($p = 0.2286$) in Q4881g and 8.3 points ($p = 0.0215$) in Q4882g versus 6.1 for each of the corresponding placebo groups. In all three Phase III studies, the change from baseline to week 12 in the overall DLQI for the 300 mg treatment group was statistically significantly ($p < 0.001$) greater compared to placebo. The 150 mg omalizumab group showed a clinically notable difference to placebo in study Q4882g ($p = 0.022$) (Figure 7).

Figure 7 Change from baseline to week 12 in overall Dermatology Life Quality Index, Studies Q4881g, Q4882g and Q4883g

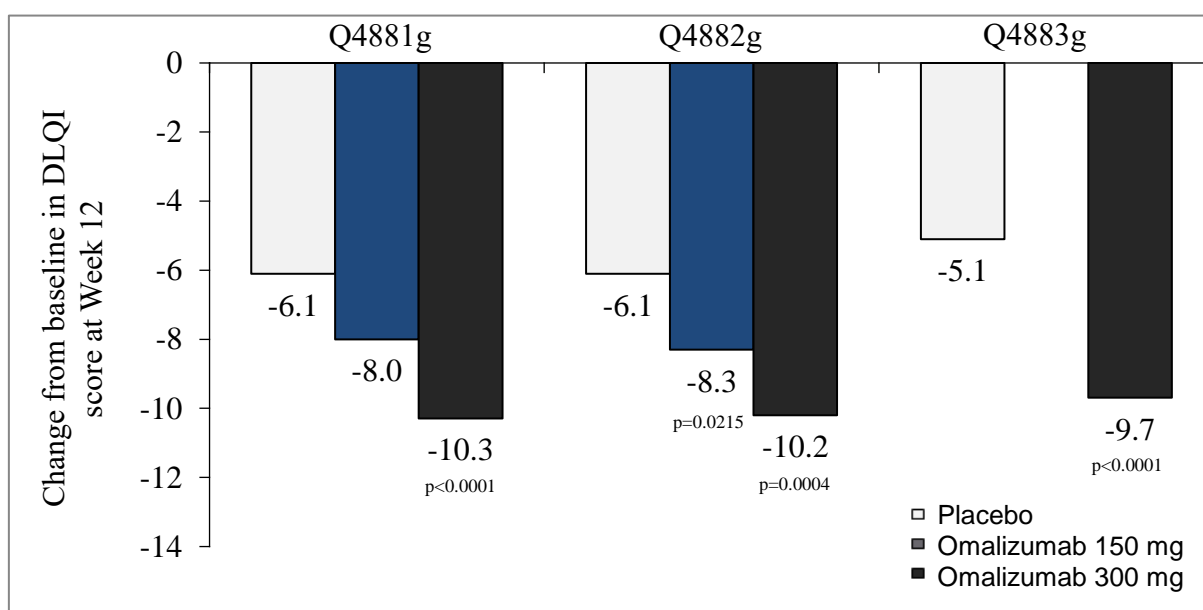

DLQI=Dermatology Life Quality Index
p values are omalizumab vs placebo group

Efficacy after 24 weeks of treatment

Table 12 shows the results after 24 weeks of treatment. Similar magnitudes of response are seen at 12 weeks.

Table 12 Efficacy results after 24 weeks of treatment, Studies Q4881g and Q4883g (mITT population*)

Parameter Study	Week	Placebo	Omalizumab 150 mg	Omalizumab 300 mg
Change from baseline in weekly itch severity score (BOCF), mean				
Study Q4881g	Week 24	-5.41	-6.47	-9.84**
Study Q4883g	Week 24	-4.03	NA	-8.60**
Change from baseline in UAS7 (BOCF), mean				
Study Q4881g	Week 24	-11.73	-14.21	-22.11**
Study Q4883g	Week 24	-8.85	NA	-19.15**
Proportion of patients with UAS7 ≤ 6, % patients				
Study Q4881g	Week 24	25.0	36.3	61.7**
Study Q4883g	Week 24	16.9	NA	55.6**
Proportion of patients with UAS7 = 0, % patients				
Study Q4881g	Week 24	12.5	20.0	48.1**
Study Q4883g	Week 24	3.6	NA	42.5**
*Modified intent-to-treat (mITT) population: included all patients who were randomised and received at least one dose of study medication				
** p-value≤0.0001 for the corresponding test statistics between the treatment and the placebo				
NA: Not applicable.				
BOCF: Baseline Observation Carried Forward				

NON-CLINICAL SAFETY DATA

There was no evidence of a systemic anaphylactic response due to mast-cell degranulation in either adult or juvenile cynomolgus monkeys. Circulating omalizumab: IgE antibody complexes were present in all monkey studies, however there was no evidence of immune complex-mediated disease in any organ (including the kidney) following omalizumab administration. Omalizumab: IgE complexes do not fix complement or mediate complement-dependent cytotoxicity.

Chronic administration of omalizumab at dose levels of up to 250 mg/kg (at least 14-fold the highest recommended clinical dose in mg/kg) was well tolerated in non-human primates (both adult and juvenile animals), with the exception of a dose-related decrease in platelet counts that occurred in several non-human primate species, at serum concentrations generally in excess of maximum human exposure in pivotal clinical trials. Juvenile monkeys were more sensitive to the platelet effects than adult monkeys. In addition, acute hemorrhage and inflammation were observed at injection sites in cynomolgus monkeys, consistent with a localized immune response to repeated subcutaneous administration of a heterologous protein. Formal carcinogenicity studies have not been conducted with omalizumab.

Antibodies to omalizumab were detected in some monkeys following subcutaneous or intravenous administration. This was not unexpected based on administration of a heterologous protein. Some animals could not be evaluated because of high serum omalizumab concentrations, high IgE levels, or both. However, the animals maintained high serum omalizumab concentrations throughout the treatment periods of the studies, and there was no apparent toxicity due to the presence of anti-omalizumab antibodies.

Reproduction, milk excretion and fertility studies in animals are described in section PREGNANCY, LACTATION, FEMALES AND MALES OF REPRODUCTIVE POTENTIAL.

INCOMPATIBILITIES

Powder and solvent for solution for injection: Xolair should not be mixed with any medication or diluents other than sterile water for injection.

Solution for injection in pre-filled syringe: This medicinal product must not be mixed with other medicinal products.

Special precautions for storage

Xolair must be stored in a refrigerated condition at 2°C–8°C. Do not freeze. In order to protect from light, store in the original package. The shelf life includes potential temperature excursions.

See folding box.

Xolair must not be used after the date marked “EXP” on the pack.

Xolair must be kept out of the reach and sight of children.

INSTRUCTIONS FOR USE AND HANDLING

Xolair powder and solvent for solution for injection:

The following information is intended for medical or healthcare professionals only.

Xolair 75 mg and 150 mg powder for solution for injection are supplied in a single-use vial and contain no antibacterial preservatives. Chemical and physical stability of the reconstituted product has been demonstrated for 8 hours at 2°C to 8°C and for 4 hours at 30°C. From a microbiological point of view, the product should be used immediately after reconstitution. If not used immediately, in-use storage times and conditions prior to use are the responsibility of the user and should normally not be longer than 8 hours at 2°C to 8°C, unless reconstitution has taken place in controlled and validated aseptic conditions

The lyophilized product takes 15 to 20 minutes to dissolve, although in some cases it may take longer. The fully reconstituted product will appear clear to slightly opalescent, colorless to pale brownish-yellow and may have a few small bubbles or foam around the edge of the vial. Because the reconstituted product is somewhat viscous, care must be taken to **WITHDRAW ALL OF THE PRODUCT** from the vial before expelling any air or excess solution from the syringe in order to obtain the full 0.6 mL or 1.2 mL dose.

To prepare Xolair for subcutaneous administration, please adhere to the following instructions:

For Xolair 75 mg vials

1. Draw 0.9 mL of water for injection from the ampoule into a syringe equipped with a large-bore 18-gauge needle.
2. With the vial placed upright on a flat surface, insert the needle and transfer the water for injections into the omalizumab vial using standard aseptic techniques, **directing the water for injection directly onto the powder.**
3. Keeping the vial in an upright position, vigorously swirl the upright vial (do not shake) for approximately 1 minute to evenly wet the powder.

4. To aid in dissolution after completing step 3, gently swirl the upright vial for 5 to 10 seconds approximately every 5 minutes in order to dissolve any remaining solids.

Note that in some cases it may take longer than 20 minutes for the powder to dissolve completely. If this is the case, repeat step 4 until there are no visible gel-like particles in the solution.

When the product is fully dissolved, there should be no visible gel-like particles in the solution. It is acceptable to have small bubbles or foam around the edge of the vial. The reconstituted product will appear clear or slightly opaque. Do not use if foreign particles are present.

5. Invert the vial for 15 seconds in order to allow the solution to drain towards the stopper. Using a new 3-cc syringe equipped with a large-bore, 18-gauge needle, insert the needle into the inverted vial. Position the needle tip at the very bottom of the solution in the vial stopper when drawing the solution into the syringe. Before removing the needle from the vial, pull the plunger all the way back to the end of the syringe barrel in order to **remove all of the solution** from the inverted vial.
6. Replace the 18-gauge needle with a 25-gauge needle for subcutaneous injection.
7. Expel air, large bubbles, and any excess solution in order to obtain the required 0.6 mL dose. A thin layer of small bubbles may remain at the top of the solution in the syringe. Because the solution is slightly viscous, the injection may take 5 to 10 seconds to administer. The vial delivers 0.6 mL (75 mg) of Xolair.
8. The injections are administered subcutaneously in the arm, thigh, or lower abdomen (but not the area of 5 centimeters around the navel). Do not inject into areas where the skin is tender, bruised, red, or hard. Avoid areas with scars or stretch marks. If you need to give more than one injection for the full dose, choose a different injection site each time you inject.

For Xolair 150 mg vials

1. Draw 1.4 mL of water for injection from the ampoule into a syringe equipped with a large-bore 18-gauge needle.
2. With the vial placed upright on a flat surface, insert the needle and transfer the water for injections into the omalizumab vial using standard aseptic techniques, **directing the water for injections directly onto the powder.**
3. Keeping the vial in an upright position, vigorously swirl the upright vial (do not shake) for approximately 1 minute to evenly wet the powder.
4. To aid in dissolution after completing step 3, gently swirl the upright vial for 5 to 10 seconds approximately every 5 minutes in order to dissolve any remaining solids.

Note that in some cases it may take longer than 20 minutes for the powder to dissolve completely. If this is the case, repeat step 4 until there are no visible gel-like particles in the solution.

When the product is fully dissolved, there should be no visible gel-like particles in the solution. It is acceptable to have small bubbles or foam around the edge of the vial. The reconstituted product will appear clear or slightly opaque. Do not use if foreign particles are present.

5. Invert the vial for 15 seconds in order to allow the solution to drain towards the stopper. Using a new 3-cc syringe equipped with a large-bore, 18-gauge needle, insert the needle into the inverted vial. Position the needle tip at the very bottom of the solution in the vial stopper when drawing the solution into the syringe. Before removing the needle from the vial, pull the plunger all the way back to the end of the syringe barrel in order to **remove all of the solution** from the inverted vial.
6. Replace the 18-gauge needle with a 25-gauge needle for subcutaneous injection.
7. Expel air, large bubbles, and any excess solution in order to obtain the required 1.2 mL dose. A thin layer of small bubbles may remain at the top of the solution in the syringe. Because the solution is slightly viscous, the injection may take 5 to 10 seconds to administer. The vial delivers 1.2 mL (150 mg) of Xolair.
8. The injections are administered subcutaneously in the arm, thigh, or lower abdomen (but not the area of 5 centimeters around the navel). Do not inject into areas where the skin is tender, bruised, red, or hard. Avoid areas with scars or stretch marks. If you need to give more than one injection for the full dose, choose a different injection site each time you inject.

Special precautions for disposal - Xolair powder and solvent for solution for injection

Any unused product or waste material should be disposed of in accordance with local requirements.

Instructions for use and handling - Xolair solution for injection in pre-filled syringe

The following information is intended for medical or healthcare professionals only.

Before using the syringe, please read the following information carefully.

Each Xolair pack contains a pre-filled syringe individually sealed in a plastic wrapper.

Parts of the pre-filled syringe

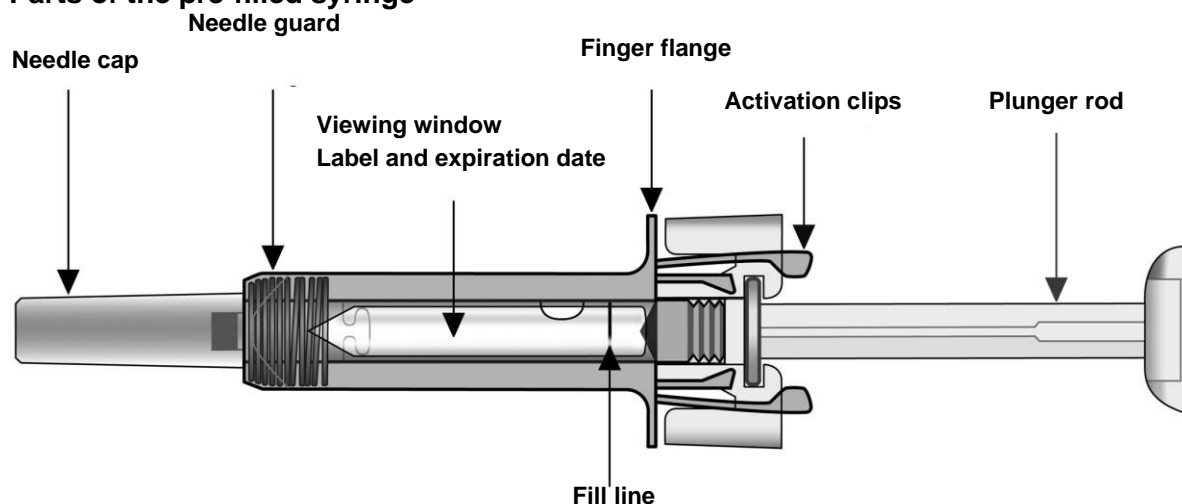

Important Safety Information

Caution: Keep the syringe out of the reach of children.

1. The needle cap of the syringe may contain dry rubber (latex), which should not be handled by persons sensitive to this substance.
2. Do not open the sealed outer box until you are ready to use the syringe.
3. Do not use the syringe if either the seal on the outer box or the plastic wrapper is broken, as it may be not safe for you to use.
4. Do not use if the syringe has been dropped onto a hard surface or dropped after removing the needle cap.
5. Never leave the syringe where others might tamper with it.
6. Be careful not to touch the device activation clips (see first illustration) at any time. By touching them, the safety device may self-activate.
7. Do not remove the needle cap until just before you give the injection.
8. The syringe cannot be re-used. Dispose of the used syringe immediately after use.

Storage of the pre-filled syringe

1. Store the syringe sealed in its outer box in the refrigerator between 2°C and 8°C (36°F and 46°F). **DO NOT FREEZE.**
2. Take the syringe out of the refrigerator and allow it to reach room temperature before preparing it for injection (it will take about 20 minutes).
3. Do not use the syringe after the expiration date shown on the outer box or syringe label. If it has expired, return the entire pack to the pharmacy.

The Injection Site

The injection site is the place on the body where you are going to use the syringe. Xolair can be injected in either the upper outer thigh or the upper outer arm. If you need more than one injection at a time, repeat the injection in the opposite thigh or arm, avoiding urticarial lesions.

Preparing the syringe for use

Warning: Prior to completion of the injection, avoid contact with the device activation clips (see first illustration) to keep from prematurely covering the needle with the needle guard.

1. Take the box containing the syringe out of the refrigerator and leave it for about 20 minutes so that it reaches room temperature (leave the syringe in the box to protect it from light).
2. If necessary, the syringe can be returned to the refrigerator for use at a later time, but this must not be done more than once. The cumulative time during which the syringe is kept at room temperature (25°C) must not exceed 48 hours.
3. When you are ready to use the syringe, wash your hands thoroughly with soap and water.
4. Clean the injection site.
5. Remove the plastic tray from the box, peel back the paper cover, and remove the syringe.

6. Inspect the syringe. **DO NOT USE** if it is broken or if the liquid looks cloudy or contains particles. In all these cases, return the entire product pack to the pharmacy.
7. Hold the syringe horizontally as shown below, look into the viewing window to check the dose (75 mg or 150 mg) of medicine and the expiration date printed on the label. Note: Rotate the internal syringe as shown below so the label can be read in the viewing window.

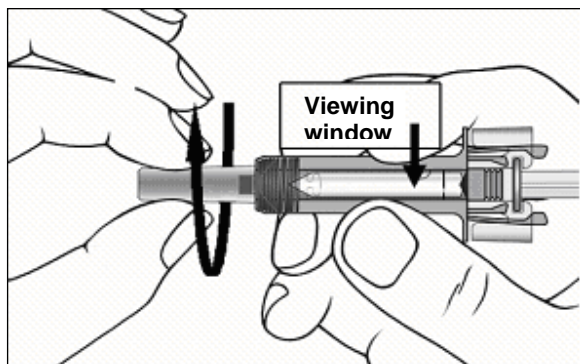

DO NOT USE if the product has expired or if the dose is incorrect. In either case, return the entire product pack to the pharmacy.

8. Hold the syringe vertically with the plunger uppermost and tap the side of the syringe against your finger to allow the air bubble to rise.
9. Check to see if the liquid level is at or above the minimum fill line. If the liquid is below the fill line, return the entire pack to the pharmacy.

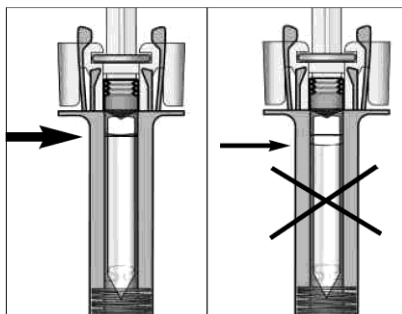

How to use the syringe

Step 1: Holding the syringe with the needle pointing upwards, carefully pull off the needle cap from the syringe and discard it. Do not touch the exposed needle. Then, gently tap the syringe with your finger until the air bubble rises to the top of the syringe. Slowly push the plunger up to force the air bubble out of the syringe without inadvertently expelling solution.

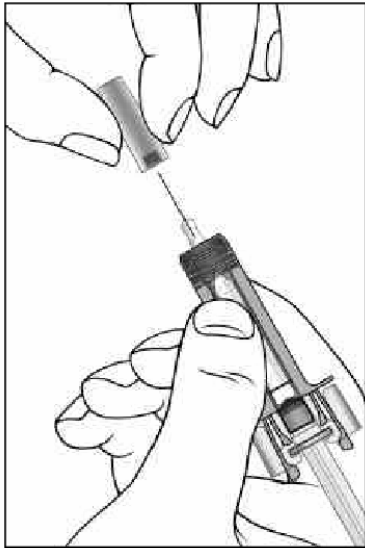

Step 2: Gently pinch the skin at the injection site. Insert the needle into the skin fold.

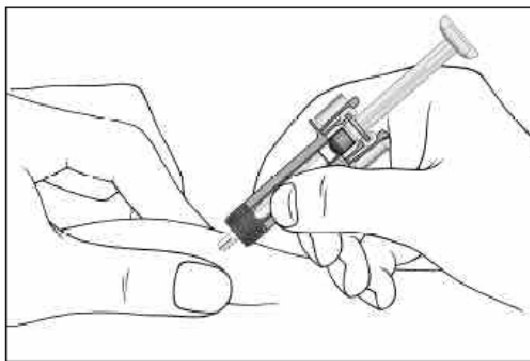

Step 3: Holding onto the finger flange, slowly press the plunger all the way down until all the solution is injected.

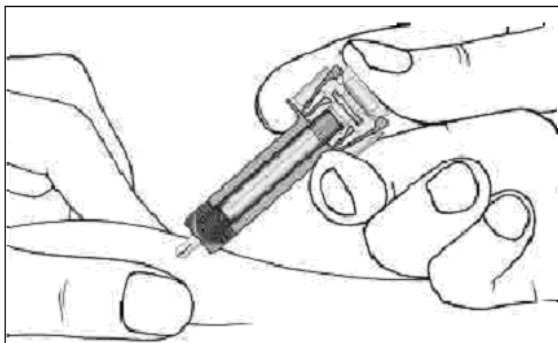

Step 4: After the complete dose is given, remove the needle from the skin while holding the plunger down.

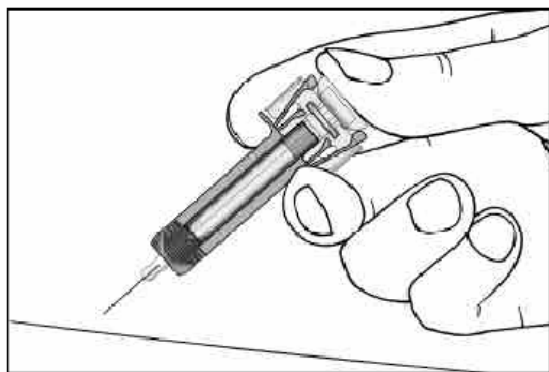

Step 5: Slowly release the plunger and allow the needle guard to automatically cover the exposed needle.

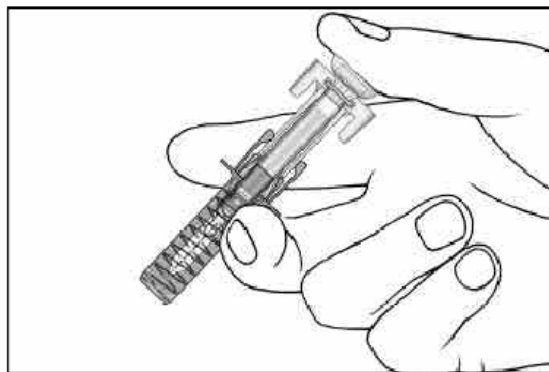

NOTE: If the needle guard does not extend automatically, firmly push on the plunger. Then release the plunger and allow the guard to cover the needle.

Step 6: Dispose the used syringe immediately in a sharps container.

Special precautions for disposal - Xolair solution for injection in pre-filled syringe

Any unused product or waste material should be disposed of in accordance with local requirements.

Manufacturer:

See folding box.

International Package Leaflet

Information issued: 29-Jun-2023

® = registered trademark

Novartis Pharma AG, Basel, Switzerland