

Instructions for administration

STELARA 45 mg solution for injection

At the start of treatment, your healthcare provider will assist you with your first injection. However, you and your doctor may decide that you may inject STELARA yourself. If this happens, you will get training on how to inject STELARA. Talk to your doctor if you have any questions about giving yourself an injection.

- Do not mix STELARA with other liquids for injection
- Do not shake STELARA vials. This is because strong shaking may damage the medicine. Do not use the medicine if it has been shaken strongly.

1. Check the number of vials and prepare the materials:

Take the vial(s) out of the refrigerator. Let the vial stand for about half an hour. This will let the liquid come to a comfortable temperature for injection (room temperature).

Check the vial(s) to make sure:

- the number of vials and strength is correct
 - If your dose is 45 mg or less, you will get one 45 mg vial of STELARA
 - If your dose is 90 mg you will get two 45 mg vials of STELARA and you will need to give yourself two injections. Choose two different sites for these injections (for example one injection in the right thigh and the other injection in the left thigh), and give the injections one right after the other. Use a new needle and syringe for each injection.
- it is the right medicine
- it has not passed its expiry date
- the vial is not damaged and the seal is not broken
- the solution in the vial is clear to slightly opalescent (having a pearl-like shine) and colourless to light yellow
- the solution is not discoloured or cloudy and does not contain any foreign particles
- the solution is not frozen.

Children weighing less than 60 kg need a dose lower than 45 mg. Make sure you know the proper amount (volume) to remove from the vial and type of syringe needed for dosing. If you don't know the amount or type of syringe needed, contact your healthcare provider for further instruction.

Get everything together that you need and lay out on a clean surface. This includes a syringe, needle, antiseptic wipes, a cotton ball or gauze, and a sharps container (see Figure 1).

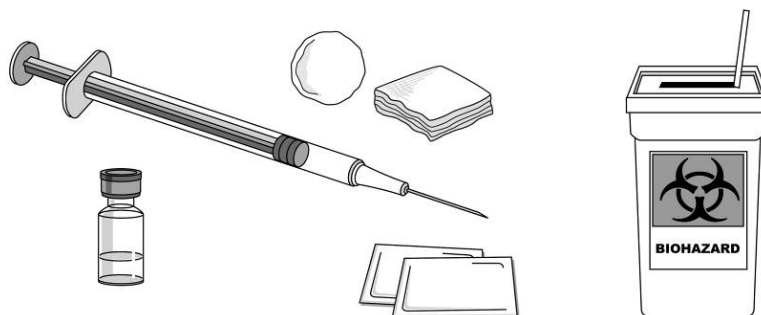
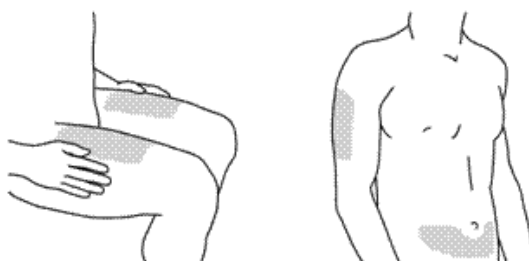

Figure 1

2. Choose and prepare the injection site:

Choose an injection site (see Figure 2)

- STELARA is given by injection under the skin (subcutaneously)
- Good places for the injection are the upper thigh or around the belly (abdomen) at least 5 cm away from the navel (belly button)
- If possible, do not use areas of skin that show signs of psoriasis
- If someone will assist in giving you the injection, then he or she may also choose the upper arms as an injection site



*Areas in gray are recommended injection sites.

Figure 2

Prepare the injection site

- Wash your hands very well with soap and warm water
- Wipe the injection site on the skin with an antiseptic wipe
- Do not touch this area again before giving the injection

3. Prepare the dose:

- Take the cap off the top of the vial (see Figure 3)



Figure 3

- Do not remove the stopper
- Clean the stopper with an antiseptic swab
- Put the vial on a flat surface.
- Pick up the syringe and remove the needle cover
- Do not touch the needle or let the needle touch anything
- Push the needle through the rubber stopper
- Turn the vial and the syringe upside down
- Pull on the syringe plunger to fill the syringe with the amount of liquid prescribed by your doctor
- It is important that the needle is always in the liquid. This stops air bubbles forming in the syringe (see Figure 4)

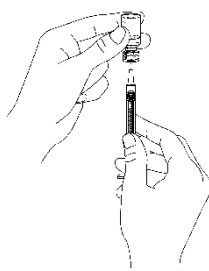

Figure 4

- Remove the needle from the vial
- Hold the syringe with the needle pointing up to see if it has any air bubbles inside
- If there are air bubbles, tap the side gently until the air bubbles go to the top of the syringe (see Figure 5)

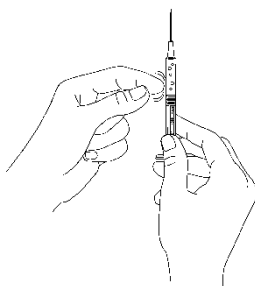

Figure 5

- Then press the plunger until all of the air (but none of the liquid) has been removed
- Do not lay the syringe down or allow the needle to touch anything.

4. Inject the dose:

- Gently pinch the cleaned skin between your thumb and index finger. Do not squeeze it tightly
- Push the needle into the pinched skin
- Push the plunger with your thumb as far as it will go to inject all of the liquid. Push it slowly and evenly, keeping the skin gently pinched
- When the plunger is pushed as far as it will go, take out the needle and let go of the skin

5. After the injection:

- Press an antiseptic wipe over the injection site for a few seconds after the injection
- There may be a small amount of blood or liquid at the injection site. This is normal

- You can press a cotton ball or gauze over the injection site and hold for 10 seconds
- Do not rub the skin at the injection site. You may cover the injection site with a small adhesive bandage, if necessary.

6. Disposal:

- Used syringes and needles should be placed in a puncture-resistant container, like a sharps container. Never re-use needles and syringes, for your safety and health, and for the safety of others. Dispose of your sharps container according to your local regulations
- Empty vials, antiseptic wipes, and other supplies can be disposed of in your garbage.

Instructions for administration

STELARA 45 mg solution for injection in pre-filled syringe

At the start of treatment, your healthcare provider will assist you with your first injection. However, you and your doctor may decide that you may inject STELARA yourself. If this happens, you will get training on how to inject STELARA. Talk to your doctor if you have any questions about giving yourself an injection.

- Do not mix STELARA with other liquids for injection
- Do not shake STELARA pre-filled syringes. This is because strong shaking may damage the medicine. Do not use the medicine if it has been shaken strongly.

Figure 1 shows what the pre-filled syringe looks like.

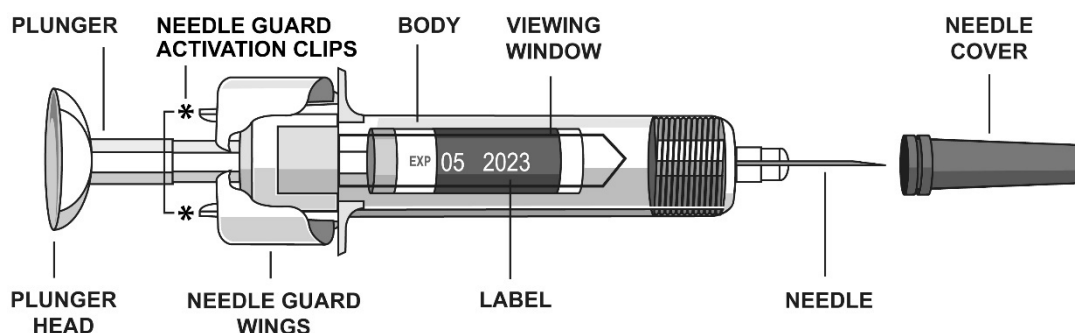

Figure 1

1. Check the number of pre-filled syringes and prepare the materials:

Preparing for use of the pre-filled syringe

- Take the pre-filled syringe(s) out of the refrigerator. Let the pre-filled syringe stand outside the box for about half an hour. This will let the liquid come to a comfortable temperature for injection (room temperature). Do not remove the syringe's needle cover while allowing it to reach room temperature
- Hold the pre-filled syringe by the body of the syringe with the covered needle pointing upward
- Do not hold by the plunger head, plunger, needle guard wings, or needle cover
- Do not pull back on the plunger at any time
- Do not remove the needle cover from the pre-filled syringe until instructed to do so
- Do not touch the needle guard activation clips (as indicated by asterisks * in Figure 1) to prevent prematurely covering the needle with the needle guard.

Check the pre-filled syringe(s) to make sure

- the number of pre-filled syringes and strength is correct
 - If your dose is 45 mg you will get one 45 mg pre-filled syringe of STELARA
 - If your dose is 90 mg you will get two 45 mg pre-filled syringes of STELARA and you will need to give yourself two injections. Choose two different sites for these injections (e.g. one injection in the right thigh and the other injection in the left thigh), and give the injections one right after the other.
- it is the right medicine
- it has not passed its expiry date
- the pre-filled syringe is not damaged
- the solution in the pre-filled syringe is clear to slightly opalescent (having a pearl-like shine) and colourless to light yellow
- the solution in the pre-filled syringe is not discoloured or cloudy and does not contain any foreign particles
- the solution in the pre-filled syringe is not frozen.

Get everything together that you need and lay out on a clean surface. This includes antiseptic wipes, a cotton ball or gauze, and a sharps container.

2. Choose and prepare the injection site:

Choose an injection site (see Figure 2)

- STELARA is given by injection under the skin (subcutaneously)
- Good places for the injection are the upper thigh or around the belly (abdomen) at least 5 cm away from the navel (belly button)
- If possible, do not use areas of skin that show signs of psoriasis
- If someone will assist in giving you the injection, then he or she may also choose the upper arms as an injection site

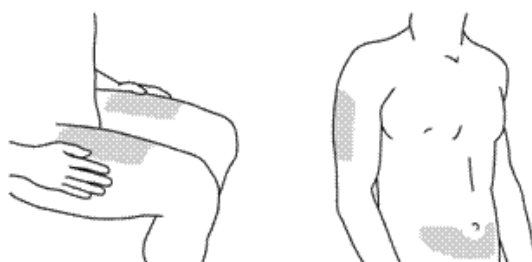

Figure 2

Prepare the injection site

- Wash your hands very well with soap and warm water
- Wipe the injection site on the skin with an antiseptic wipe
- **Do not** touch this area again before giving the injection

3. Remove the needle cover (see Figure 3):

- The needle cover should **not** be removed until you are ready to inject the dose
- Pick up the pre-filled syringe, hold the body of the syringe with one hand
- Pull the needle cover straight off and throw it away. Do not touch the plunger while you do this

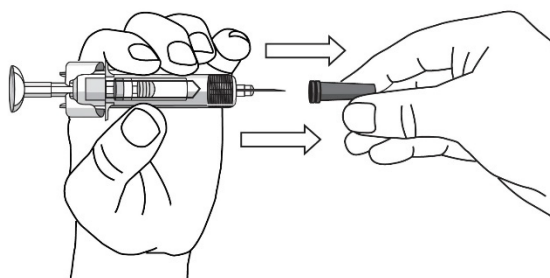

Figure 3

- You may notice an air bubble in the pre-filled syringe or a drop of liquid at the end of the needle. These are both normal and do not need to be removed
- Do not touch the needle or allow it to touch any surface
- Do not use the pre-filled syringe if it is dropped without the needle cover in place. If this happens, please contact your doctor or pharmacist
- Inject the dose promptly after removing the needle cover.

4. Inject the dose:

- Hold the pre-filled syringe with one hand between the middle and index fingers and place the thumb on top of the plunger head and use the other hand to gently pinch the cleaned skin between your thumb and index finger. Do not squeeze it tightly
- Do not pull back on the plunger at any time
- In a single and swift motion, insert the needle through the skin as far as it will go (see Figure 4)

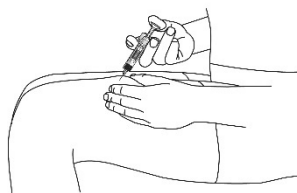

Figure 4

- Inject all of the medication by pushing in the plunger until the plunger head is completely between the needle guard wings (see Figure 5)



Figure 5

- When the plunger is pushed as far as it will go, continue to keep the pressure on the plunger head, take out the needle and let go of the skin (see Figure 6)

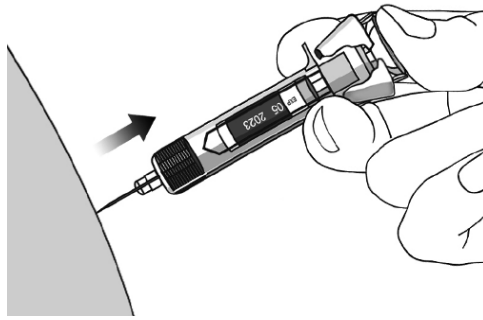

Figure 6

- Slowly take your thumb off the plunger head to allow the empty syringe to move up until the entire needle is covered by the needle guard, as shown by Figure 7:

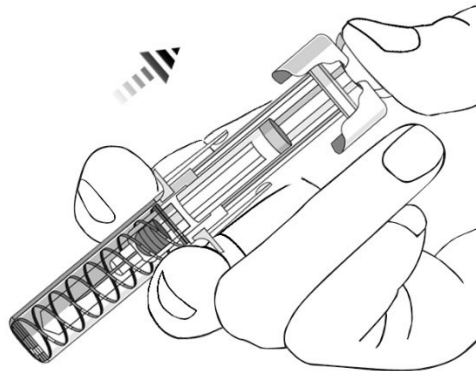

Figure 7

5. After the injection:

- Press an antiseptic wipe over the injection site for a few seconds after the injection.
- There may be a small amount of blood or liquid at the injection site. This is normal.
- You can press a cotton ball or gauze over the injection site and hold for 10 seconds.

- Do not rub the skin at the injection site. You may cover the injection site with a small adhesive bandage, if necessary.

6. Disposal:

- Used syringes should be placed in a puncture-resistant container, like a sharps container (see Figure 8). Never re-use a syringe, for your safety and health and for the safety of others. Dispose of your sharps container according to your local regulations
- Antiseptic wipes and other supplies can be disposed of in your garbage.

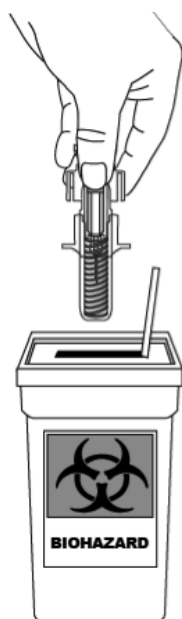

Figure 8

Instructions for administration

STELARA 90 mg solution for injection in pre-filled syringe

At the start of treatment, your healthcare provider will assist you with your first injection. However, you and your doctor may decide that you may inject STELARA yourself. If this happens, you will get training on how to inject STELARA. Talk to your doctor if you have any questions about giving yourself an injection.

- Do not mix STELARA with other liquids for injection
- Do not shake STELARA pre-filled syringes. This is because strong shaking may damage the medicine. Do not use the medicine if it has been shaken strongly.

Figure 1 shows what the pre-filled syringe looks like.

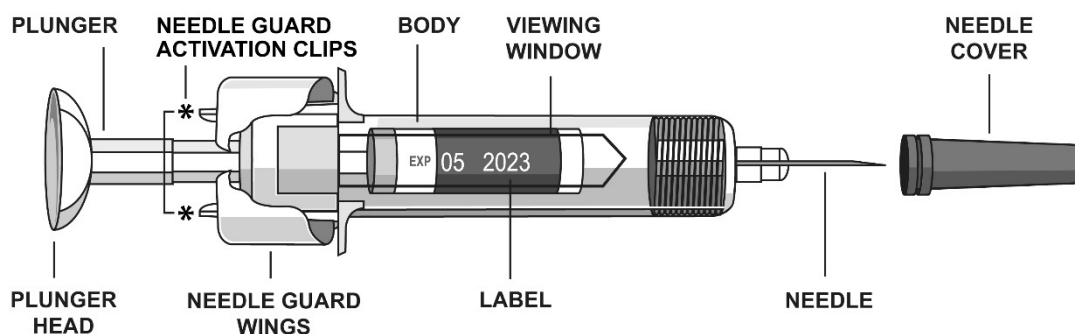

Figure 1

1. Check the number of pre-filled syringes and prepare the materials:

Preparing for use of the pre-filled syringe

- Take the pre-filled syringe(s) out of the refrigerator. Let the pre-filled syringe stand outside the box for about half an hour. This will let the liquid come to a comfortable temperature for injection (room temperature). Do not remove the syringe's needle cover while allowing it to reach room temperature
- Hold the pre-filled syringe by the body of the syringe with the covered needle pointing upward
- Do not hold by the plunger head, plunger, needle guard wings, or needle cover
- Do not pull back on the plunger at any time

- Do not remove the needle cover from the pre-filled syringe until instructed to do so
- Do not touch the needle guard activation clips (as indicated by asterisks * in Figure 1) to prevent prematurely covering the needle with the needle guard.

Check the pre-filled syringe(s) to make sure

- the number of pre-filled syringes and strength is correct
 - If your dose is 90 mg you will get one 90 mg pre-filled syringe of STELARA.
- it is the right medicine
- it has not passed its expiry date
- the pre-filled syringe is not damaged
- the solution in the pre-filled syringe is clear to slightly opalescent (having a pearl-like shine) and colourless to light yellow
- the solution in the pre-filled syringe is not discoloured or cloudy and does not contain any foreign particles
- the solution in the pre-filled syringe is not frozen.

Get everything together that you need and lay out on a clean surface. This includes antiseptic wipes, a cotton ball or gauze, and a sharps container.

2. Choose and prepare the injection site:

Choose an injection site (see Figure 2)

- STELARA is given by injection under the skin (subcutaneously)
- Good places for the injection are the upper thigh or around the belly (abdomen) at least 5 cm away from the navel (belly button)
- If possible, do not use areas of skin that show signs of psoriasis
- If someone will assist in giving you the injection, then he or she may also choose the upper arms as an injection site.

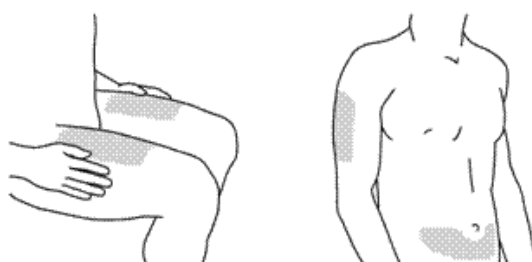

Figure 2

Prepare the injection site

- Wash your hands very well with soap and warm water
- Wipe the injection site on the skin with an antiseptic wipe
- **Do not** touch this area again before giving the injection.

3. Remove the needle cover (see Figure 3):

- The needle cover should **not** be removed until you are ready to inject the dose
- Pick up the pre-filled syringe, hold the body of the syringe with one hand
- Pull the needle cover straight off and throw it away. Do not touch the plunger while you do this

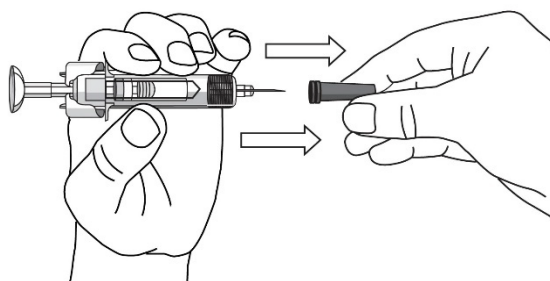

Figure 3

- You may notice an air bubble in the pre-filled syringe or a drop of liquid at the end of the needle. These are both normal and do not need to be removed
- Do not touch the needle or allow it to touch any surface
- Do not use the pre-filled syringe if it is dropped without the needle cover in place. If this happens, please contact your doctor or pharmacist
- Inject the dose promptly after removing the needle cover.

4. Inject the dose:

- Hold the pre-filled syringe with one hand between the middle and index fingers and place the thumb on top of the plunger head and use the other hand to gently pinch the cleaned skin between your thumb and index finger. Do not squeeze it tightly
- Do not pull back on the plunger at any time
- In a single and swift motion, insert the needle through the skin as far as it will go (see Figure 4)

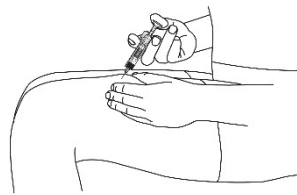

Figure 4

- Inject all of the medication by pushing in the plunger until the plunger head is completely between the needle guard wings (see Figure 5)



Figure 5

- When the plunger is pushed as far as it will go, continue to keep the pressure on the plunger head, take out the needle and let go of the skin (see Figure 6)

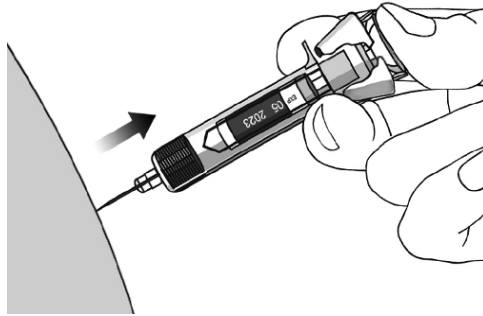

Figure 6

- Slowly take your thumb off the plunger head to allow the empty syringe to move up until the entire needle is covered by the needle guard, as shown by Figure 7:

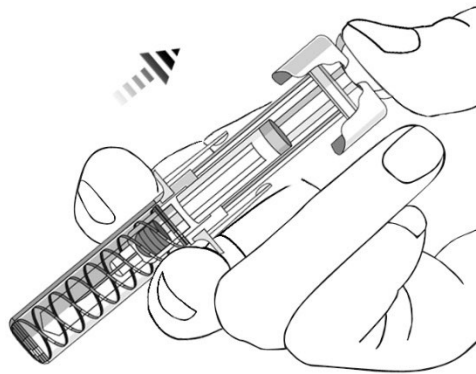

Figure 7

5. After the injection:

- Press an antiseptic wipe over the injection site for a few seconds after the injection.
- There may be a small amount of blood or liquid at the injection site. This is normal.
- You can press a cotton ball or gauze over the injection site and hold for 10 seconds.
- Do not rub the skin at the injection site. You may cover the injection site with a small adhesive bandage, if necessary.

6. Disposal:

- Used syringes should be placed in a puncture-resistant container, like a sharps container (see Figure 8). Never re-use a syringe, for your safety and health and for the safety of others. Dispose of your sharps container according to your local regulations
- Antiseptic wipes and other supplies can be disposed of in your garbage.

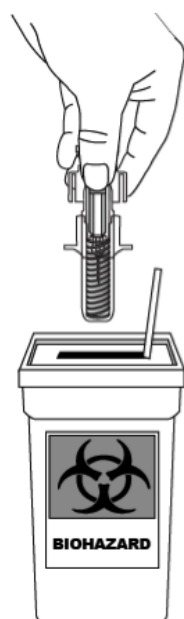

Figure 8

Date of revision of the text

EU SmPC version 26-Mar-2023_Editorial change

Manufacturer

Cilag AG, Schaffhausen, Swiss Confederation

Marketing Authorization Number

1C 17/57 (NB)

Date of Authorization

STELARA EU SmPC version 25-Sep-2024_add cancel PIL portion
Created on 10-Feb-2025

24 June 2014

Imported by

Janssen-Cilag Ltd., Bangkok, Thailand

To report Suspected Adverse Reactions, please contact us at aepqcjacth@its.jnj.com

For any product information, please contact us at medinfosea@its.jnj.com

Please see full prescribing information at <https://ndi.fda.moph.go.th>